

TM 11-5835-224-12

DEPARTMENT OF THE ARMY TECHNICAL MANUAL

OPERATOR AND ORGANIZATIONAL
MAINTENANCE MANUAL

CODER-BURST
TRANSMISSION
GROUP AN/GRA-71

This copy is a reprint which includes
current pages from Changes 2 and 5.

HEADQUARTERS, DEPARTMENT OF THE ARMY

MAY 1964

CHANGE

DEPARTMENT OF THE ARMY
HEADQUARTERS
Washington, D.C., 8 July 1969

No. 2

**Operator and Organizational Maintenance
Manual**

**CODER-BURST TRANSMISSION GROUP
AN/GRA-71**

TM 11-5835-224-12, 27 May 1964, is changed as follows:

Title is changed as shown above (as changed by C 1, 24 Jun 66).

The parenthetical reference to previous changes *example*: page 1 of C 2) indicates that pertinent material was published in that change.

Page 4, preface, paragraph A. Delete paragraph A (as changed by C 1, 24 Jun 66), and substitute:

A. Indexes of Equipment Publications

1. *DA Pam 310-4*. Refer to the latest issue of DA Pam 3104 to determine whether there are new editions, changes, or additional publications pertaining to the equipment.

2. *DA Pam 310-7*. Refer to the latest issue of DA Pam 310-7 to determine whether there are modification work orders (MWO's) pertaining to the equipment.

*This change supersedes C 1, 24 June 1966.

Paragraph B. Designate the -first subparagraph as:

1. (As changed by C1, 24 Jun 66) Delete the following subparagraphs and substitute:

2. *Report of Packaging and Handling Deficiencies.* Fill out and forward DD Form 6 (Report of Packaging and Handling Deficiencies) as prescribed in AR 700-58 (Army), NAVSU7P Publication 378 (Navy), AFR 714 (Air Force), and MCO P4610-5 (Marine Corps).

3. *Discrepancy in Shipment Report (DISREP) (SF 361).* Fill out and forward Discrepancy in Shipment Report (DISREP) (SF 361) as prescribed in AR 55-38 (Army), NAVSUP Pub 459 (Navy), AFM 75-34 (Air Force), and MCO P4610.19 (Marine Corps).

4. *Reporting of Equipment Manual Improvements.* Reporting of errors, omissions, and recommendations for improving this publication by the individual user is encouraged. Reports should be submitted on DA Form 2028 (Recommended Changes to Publications) and forwarded direct to Commanding General, U.S. Army Electronics Command, ATTN: AMSEL-ME-NMP-AD, Fort Monmouth, N.J. 07703.

Page 28. Add paragraphs 2.6 and 2.7 after paragraph 2.5:

2.6 Premission Operational Check

a. *Procedure.* The equipment operator should perform a premission operational check on the AN/GRA-71 before going on an assigned mission. Locate the AN/GRA-71 and the associated radio set (para 2.7) a few hundred yards from the base station. Set -p the equipment for communication with the base station, and then record 20-word messages

on the magnetic tape in the two CA-3B cartridges. Record one message on one magnetic tape with the CO/B-8 Coder and a message on the remaining tape with the COMB Coder. Before performing this permission check, arrange with the base station for receiving the test messages. Figure 2-7 illustrates a typical example. Perform the test transmission by following the steps given in the chart below:

b. Permission Operational Chart.

Step No.	Performance procedure
1-----	Remove the cover from the KA-3 Keyer Adapter (fig. 2-3). Remove the components from the storage compartments and remove or open the covers of those compartments that have covers.
2-----	Refer to the technical manual for the authorized transmitter operating instructions. Tune the transmitter for operation with the base station. Turn the transmitter off. Some configurations do not need the KA-3 Keyer Adapter. A typical example is shown on figure 2-6. Attach the TRANS cable on the KA-3 Keyer Adapter to the transmitter.
3-----	Attach one CA-3B Cartridge (fig. 1-5) to the CO/B-8 Coder (fig. 1-2) locking pins. Press down on the CO/B-8 Coder word space button gently and slowly (fig. 3-4), and observe the following: <ol style="list-style-type: none"> <li data-bbox="412 831 916 906">a. Tape moves forward as evidenced by the movement of the white lines on the storage spool (fig. 1-5) in two steps. <li data-bbox="412 906 916 1058">b. Two distinct clicks are heard when the button is pushed downward, gently, slowly, and completely. Two distinct clicks are heard when the button is released gently and slowly. The procedure should be repeated five or six times.

Step No.	Performance procedure
4-----	Record the test message on the CA-3B Cartridge with the CO/B-8 Coder by following the message recording instructions in paragraph 2.2, steps 1 through 9.
5-----	Record a test message on the remaining CA-3B Cartridge with the CO-3B Coder by following the message recording instructions given in paragraph 2.2.2, steps 1 through 8.
6-----	<p>To transmit the messages recorded with the CO/B-8 Coder-</p> <ul style="list-style-type: none"> a. Attach the appropriate CA-3B Cartridge on the KE-8B Keyer locking pins. Wind the KE-8B Keyer spring with the windup crank (fig. 1-4). b. Attach the KA-3 Keyer Adapter KEYSER cable to the KE-8B Keyer connector receptacle, and then turn the transmitter to ON. c. Refer to paragraph 2.3, steps 4, and 5 for instructions on transmitting the message.
7-----	Repeat step 6 above to send the message recorded by the CO-3B Coder on the other CA-3B Cartridge.
8-----	Disassemble all equipment, and return to the base station to check the quality of the recorded messages. If incorrect messages are received and the defect cannot be remedied by the operator, return the AN/GRA-71 to maintenance for adjustment, or repair and adjustment.

c. Permission Test Message Reception.

(1) A typical setup for permission test message reception is shown in figure 2-7.

(2) Follow the operating instructions in TM 11-5820-357-10, to operate Radio Receiver R-390/URR, and TM 11-5895-373-12, TM 11-5835-228-12, TM 11-5835-229-12, and TM 11-5835-227-12 to op-

erate Recorder-Reproducer Set, Sound AN/GSH-17 for premission test message reception.

2.7 Operation With Radio Set AN/PRC-74A or AN/PRC-74B

a. The AN/GRA-71 may be used with several radio sets to transmit pretaped messages. A typical example of a radio set configuration for transmission without the KA-3 Keyer Adapter is shown on figure 2-6.

b. To operate the AN/PRC-74A or AN/PRC-74B in coder-burst transmission, Cable Assembly, Special Purpose, Electrical CX-10239/PRC-74 or Cable Assembly, Power Electrical CX-11468/U can be used. This cable is connected between J1 on KE-8B Keyer and an AUDIO connector on the front panel of AN/PRC-74A or AN/PRC-74B. The KW8B Keyer output is applied directly to AN/PRC-74A or AN/PRC, 74B through either a CX-10239/PRC-74 or a CX-11468/U.

NOTE

The encoded messages must be prerecorded on the CA-3B Cartridges recording tapes and be ready for use prior to turning on the AN/PRC-74A or AN/PRC74B for transmission to minimize the transmitter on-air time during the coder-burst transmission.

c. Connect the CA-B Cartridge containing the message to the burst-transmitted to the KR4B Keyer locking pins.

d. Turn on and tune the AN/PR-74A as instructed in TM 11-582059s12, or the AN/PRC-74B as instructed in TM 11-5820590-12-1.

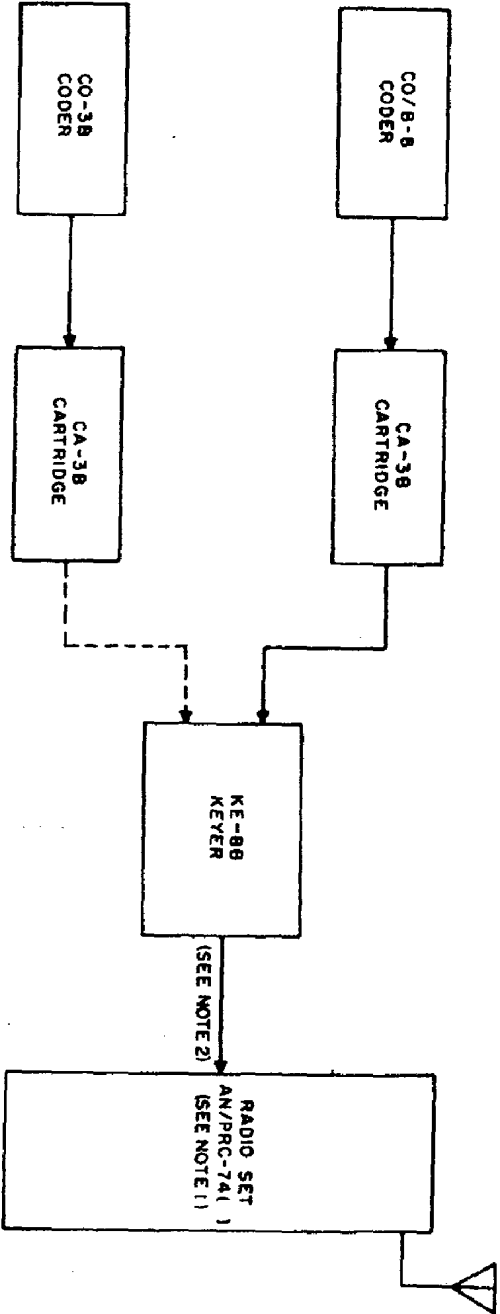

- NOTES:**
1. USE AN/PRC-74A OR AN/PRC-74B.
DO NOT USE AN/PRC-74.
 2. CX-11468/U OR CX-10239/PRG-74
CAN BE USED.

TM5835-224-12-C2-1

Figure 2-6. Keying transmitter without KA-3 Keyer Adapter.

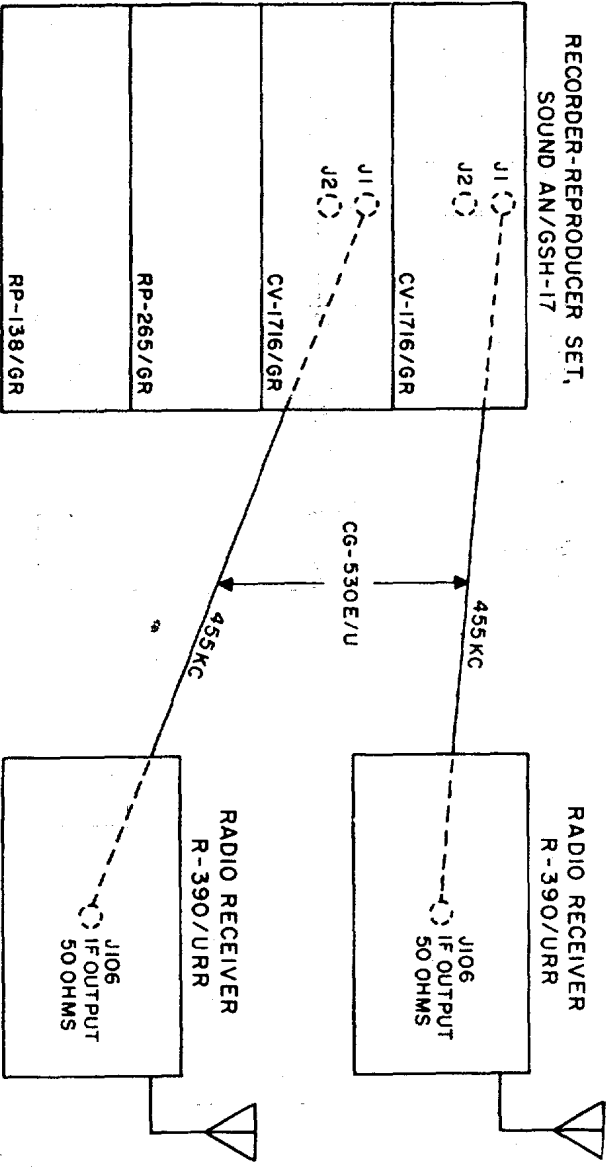

Figure 2-7. Setup for receiving coder-burst transmission for a permission equipment check.

- e. Set the KE-8B Keyer IDY switch to on. Local operating procedures establish the length of time that the IDY switch is left on.
- f. Turn the IDY switch off, and set the OFF-ON switch on the KE-8B Keyer to ON. The encoded message will be transmitted automatically.
- g. Turn the AN/PRC-74A or AN/PRC-74B off immediately after the message has been transmitted.

Page 52, paragraph 4.2.6. Delete and substitute:

4.2.6 *Cleaning.* Clean the exterior surfaces only. The exterior surfaces should be clean and free of dirt, grease, and fungus. The interior of the adapter, the coders, the keyer, and the magazines will be cleaned by a higher category of maintenance personnel.

Paragraph 4.3.1. Delete subparagraphs b, c, and d, and substitute:

b. Repeat the daily and weekly preventive maintenance checks and services as part of the organizational maintenance (para 4.2.4 through 4.2.6).

Page 53, paragraph 4.3.2. Delete and substitute the following:

4.3.2 *Tools and Material Required.* No tools are required for organizational maintenance of the AN/GRA-71. The materials required are listed below.

- a. Cleaning Compound (FSN 7930-395-9542).
- b. Cleaning cloth (soft, lintfree).

Page 55, paragraph 4.3.5. Make the following changes:

Delete sequence No. 1 in the chart in its entirety, and substitute the following note:

NOTE: IF THE AN/GRA-71 COMPONENTS HAVE BEEN CLOSED IN THE CASE FOR SOME TIME, THE ELECTRICAL SWITCH CONTACTS COULD HAVE FORMED A DARK SULPHIDE, CAUSED BY THE SUL-

PHUR IN THE RUBBER CASE LINER. THIS COULD CAUSE POOR ELECTRICAL CONTACT AND THE RESULTANT DROPPING OF DASH OR DOT SIGNALS. THE ORGANIZATIONAL MAINTENANCE MAN SHOULD TURN THE AN/GRA-71 IN TO DIRECT SUPPORT PERIODICALLY TO HAVE THESE ELECTRICAL CONTACTS CLEANED.

Change chart sequence numbers 2, 3, and 4 to read:
1, 2, and 3, respectively.

APPENDIX A

REFERENCES

Following is a list of applicable references that should be available to the operator and organizational maintenance personnel of Coder-Burst Transmission Group AN/GRA-71:

DA Pam 310-4	Index of Technical Manuals, Technical Bulletins, Supply Manuals (types 7, 8, and 9), Supply Bulletins, and Lubrication Orders.
DA Pam 310-7	U.S. Army Equipment Index of Modification Work Orders.
SB 38-100	Preservation, Packaging, Packing and Marking Materials, Supplies, and Equipment Used By the Army.
SM 11-4-5180-R09	Tool Kit, Radio Repair TK-115/G.
TB 746-10	Field Instructions for Painting and Preserving Electronics Command Equipment.
TM 11-5820-357-10	Operator's Manual: Radio Receiver R-390/URR.

TM 11-5820-474-14	Organizational, DS, and GS Maintenance Manual: Radio Set AN/GRC-109.
TM 11-5820-590-12	Operator and Organizational Maintenance Manual Including Repair Parts and Special Tool Lists: Radio Sets AN/PRC-74 and AN/PRC-74A and Power Supply PP-4514/PRC-74.
TM 11-5820-590-12-1	Operator and Organizational Maintenance Manual Including Repair Parts and Special Tool Lists: Radio Set AN/PRC-74B and Power Supply PP-4514/PRC-74.
TM 11-5835-227-12	Organizational Maintenance Manual: Recorder-Reproducer Set, Sound AN/GSH-17.
TM 11-5835-228-12	Organizational Maintenance Manual: Recorder-Reproducer, Sound RD-265/GR.
TM 11-5835-229-12	Organizational Maintenance Manual: Reproducer, Sound RP-138/GR.

TM 11-5895-373-12

Operator and Organizational Maintenance Manual: Converter, Frequency, Electronic CV-1716/GR.

TM 38-750

Army Equipment Record Procedures.

APPENDIX B
BASIC ISSUE ITEMS

Section I. INTRODUCTION

B-1. Scope

This appendix lists items comprising an operable equipment and those required for installation, operation, or operator's maintenance for Coder-Burst Transmission Group AN/GRA-71.

B-2. Explanation of Columns

The following is a list of explanations of columns in section II.

- a. Source, Maintenance, and Recoverability Codes (SMR) Column.* Not used.
- b. Federal Stock Number Column.* This column indicates the Federal stock number for the item.
- c. Description Column.* This column includes the Federal item name and any additional description of the item which may be required. A part number or the reference number is followed by the applicable five-digit Federal supply code for manufacturers. Usable on code column is not used.
- d. Unit of Measure Column* The unit used as a basis of measure (e.g., ea, pr, ft, yd, etc.) is given in this column
- e. Quantity Incorporated in Unit Column.* The total quantity of the item used in the equipment is given in this column.

f. Quantity Furnished With Equipment Column. This column lists the quantity of the item supplied for initial operation of the equipment and/or the quantities authorized to be kept on hand by the operator for maintenance of the equipment.

g. Illustration Column. Not used.

D-3. Federal Supply Code.

This paragraph lists the Federal supply code with the associated manufacturer's name.

Code number

80063-----

Manufacturers name

Army Electronics Command.

SECTION II. BASIC ISSUE ITEMS

(1) SMR CODE	(2) FEDERAL STOCK NUMBER	(3) DESCRIPTION	USABLE ON CODE	(4) UNIT OF MEAS	(5) QTY INC IN UNIT	(6) QTY FURN WITH EQUIP	(7) ILLUSTRATIONS	
							(a) FIG. NO.	(b) ITEM NO. OR REFERENCE DESIGNATION
5820-056-6856		Reference Number & Mfr Code CODER-BURST TRANSMISSION GROUP AN/GRA 71: SC-DL-556000; 80063 (This item is nonexpendable) TECHNICAL MANUAL TM 11-5835-224-12 Requisition through pinpoint account number if assigned; otherwise through nearest Adjutant General facility. A quantity of one technical manual is packed with each equipment. Where a valid need exists, additional copies may be requisitioned and kept on hand. NO PART AUTHORIZED OPERATOR/CREW NO ACCESSORIES, TOOLS OR TEST EQUIPMENT ARE TO BE ISSUED WITH THIS EQUIPMENT NO BASIC ISSUE ITEMS ARE MOUNTED IN OR ON THE EQUIPMENT		ea	1	1		

APPENDIX C

MAINTENANCE ALLOCATION

Section I. INTRODUCTION

C-1. General

This appendix provides a summary of the maintenance operations covered in the equipment literature for Coder-Burst Transmission Group AN/GRA-71. It authorizes categories of maintenance for specific maintenance functions on repairable items and components and the tools and equipment required to perform each function. This appendix may be used as an aid in planning maintenance operations.

C-2. Explanation of Format for Maintenance Allocation Chart

a. Group Number. Group numbers correspond to the reference designation prefix assigned in accordance with ASA Y32.16, *Electrical and Electronics Reference Designations*. They indicate the relation of listed items to the next higher assembly.

b. Component Assembly Nomenclature. This column lists the item names of component units, assemblies, subassemblies, and modules on which maintenance is authorized.

c. Maintenance Function. This column indicates the maintenance category at which performance of the specific maintenance function is authorized. Authorization to perform a function at any category

also includes authorization to perform that function at higher categories. The codes used represent the various maintenance categories as follows:

<i>Code</i>	<i>Maintenance category</i>
C -----	Operator/crew.
O -----	Organizational maintenance.
F -----	Direct support maintenance.
H -----	General support maintenance.
D -----	Depot maintenance.

a. Tools and Equipment. The numbers appearing in this column refer to specific tools and equipment which are identified by these numbers in section III.

e. Remarks. Self-explanatory.

C-3. Explanation of Format for Tool and Test Equipment Requirements

The columns in the tool and test equipment requirements chart are as follows:

a. Tools and Equipment. The numbers in this column coincide with the numbers used in the tools and equipment column of the MAC. The numbers indicate the applicable tool for the maintenance function.

b. Maintenance Category. The codes in this column indicate the maintenance category normally allocated the facility.

c. Nomenclature. This column lists tools, test, and maintenance equipment required to perform the maintenance functions.

d. Federal Stock Number. This column lists the Federal stock number.

e. Tool Number. Not used.

SECTION II. MAINTENANCE ALLOCATION CHART

GROUP NUMBER	COMPONENT ASSEMBLY NOMENCLATURE	MAINTENANCE FUNCTIONS										TOOLS AND EQUIPMENT	REMARKS	
		I N S P E C T	T E S T	S E R V I C E	A D J U S T	A L I G N	C A L I B R A T E	I N S T A L L	R E P L A C E	R E P A I R	O V E R H A U L			
	CODER-BURST TRANSMISSION GROUP AN/GRA-71	O	F	O									9	Exterior mechanical and visual inspection. Exterior cleaning. Interior mechanical and visual inspection. Mechanical and electrical troubleshooting. Interior cleaning and lubrication.
			F	F	F								8	Repair by replacement of: MX-4496/GRA-71; MX-4495/GRA-71; KY-468/GRA-71; MA-9/GRA-71 AND MX-4498/GRA-71.

MAINTENANCE ALLOCATION CHART

GROUP NUMBER	COMPONENT ASSEMBLY NOMENCLATURE	MAINTENANCE FUNCTIONS										TOOLS AND EQUIPMENT	REMARKS		
		I N S P E C T	T E S T	S E R V I C E	A D J U S T	A L I G N	C A L I B R A T E	I N S T A L L A C E	R E P A I R	O V E R H A U L	R E B U I L D				
	AN/GRA-71 (continued) CODER-BURST TRANSMISSION GROUP AN/GRA-71.		D			D								1, 2, 3, 4, 5, 6, 7 8 8 8	
1A	ADAPTER, KEYER MX-4498/GRA-71 (KA-3 KEYER ADAPTER)	O		O										9 3, 5, 6 9 8 8	Exterior mechanical and visual inspection. Exterior cleaning Interior mechanical and visual inspection. Mechanical and electrical troubleshooting. Interior cleaning and lubrication. Repair by replacement of: MX-4496

MAINTENANCE ALLOCATION CHART

GROUP NUMBER	COMPONENT ASSEMBLY NOMENCLATURE	MAINTENANCE FUNCTIONS											TOOLS AND EQUIPMENT	REMARKS								
		I N S P E C T	T E S T	S E R V I C E	A D J U S T	A L I G N	C A L I B R A T E	I N S T A L L	R E P L A C E	R E P A I R	O V E R H A U L	R E B I L D										
4A	AN/GRA-71 (continued) KEYER KY-468/GRA-71 (KE-8B KEYER)																					
		O		O														9	Exterior mechanical and visual inspection. Exterior cleaning.			
		F	F																3	Interior mechanical and visual inspection. Mechanical and electrical troubleshooting.		
				F																9	Interior cleaning and lubrication.	
				D															8	IDY frequency and waveshape; dot, dash and space duration; dot frequency; erase function.		
					D															8		
																					8	

MAINTENANCE ALLOCATION CHART

GROUP NUMBER	COMPONENT ASSEMBLY NOMENCLATURE	MAINTENANCE FUNCTIONS											TOOLS AND EQUIPMENT	REMARKS						
		I N S P E C T	T E S T	S E R V I C E	A D J U S T	A L I G N	C A L I B R A T E	I N S T A L L	R E P L A C E	R E P A I R	O V E R H A U L	R E B I L D								
5A	AR/GRA-71 (continued) CODER, TAPE MX-4495/GRA-71 (CO-3B CODER)																			
		O		O															9 Exterior mechanical and visual inspection. Exterior cleaning.	
		F	F																3 Interior mechanical and visual inspection.	
				F	F														9 Mechanical and electrical troubleshooting. Interior cleaning and lubrication.	
																				8
																				8
																				8
																				8

SECTION III. TOOL AND TEST EQUIPMENT REQUIREMENTS

TOOLS AND EQUIPMENT	MAINTENANCE CATEGORY	NOMENCLATURE	FEDERAL STOCK NUMBER	TOOL NUMBER
1	D	AN/GRA-71 (continued)		
2	D	CODE RECORDER RD-60/U	5805-164-7323	
3	F, D	FREQUENCY METER AN/USM-26 MUL TIMETER TS-352B/U	6625-543-1356 6625-242-5023	
4	D	OSCILLOSCOPE AN/USM-140A	6625-987-6603	
5	F, D	TEST SET, ELECTRON TUBE TV-7/U	6625-376-4939	
6	F, D	TEST SET, TRANSISTOR TS-1836	6625-893-2628	
7	D	TIME WORK GENERATOR AN/USM-108	6625-987-9564	
8	F, D	TOOL KIT TK-100/G	5180-605-0079	
9	F	TOOL KIT TK-115/G	5180-856-1578	

By Order of the Secretary of the Army:

W. C. WESTMORELAND,
General, United States Army,
Chief of Staff.

Official:

KENNETH G. WICKHAM,
Major General, United States Army
The Adjutant General.

Distribution:

Active Army:

USASA (2)	Army Pic Cen (2)
CNGB (1)	USACDCEC (10)
ACSC-E (2)	USAJFKCENSPWAR
Dir of Trans (1)	(25)
Cof Engrs (1)	Instl (21 except
TSG (1)	Fort Gordon (10)
Cot Spt S (1)	Fort Huachuca (10)
USAARENBD (2)	WSMR (5)
USAAESWBD (5)	Fort Carson (25)
USACDC Agcy (1)	Fort Knox (12)
USAMC (5)	Army Dep (2) except
USCONARC (5)	LBAD (14)
ARADCOM (5)	SAAD (30)
ARADCOM Rgn (2)	TOAD (14)
OS Maj Comd (4)	LEAD (7)
USARYIS (25)	SHAD (3)
LOGCOMD (2) except	NAAD (5)
1st LOGCOMD (10)	SVAD (5)
9th LOGCOMD (10)	CHAD (3)
USAMICOM (4)	ATAD (10)
USATECOM (2)	GENDEPS (2)
USASTRATCOM (4)	Sig Sec GENDEPS (5)
USAESC (70)	Sig Dep (12)
MDW(1)	Sig FLDMS (2)
Armies (2) except	TOPOCOM
Seventh USA (5)	USAERDAA (2)
Mil Intel Bn (4)	USAERDAW (13)
Corrs (2)	USACRREL (2)
1st av Div (5)	MAAG (2)
Inf Div (10)	USARMIS (2)
Armor Div (10)	USARMS (2)
Airborne Div (9)	USMACV (50)
Inf Bde (2)	Units organized under
Armor Bde (4)	following TOE's (2
Mechanized Bde (2)	copies each)
Airborne Bde (2)	7 (AA-AC)
Svce Colleges (2)	7-4 11-587
USASFESS (20)	7-157 11-592
USAADS7(2)	11-57 11-597
USAAMS (2)	11-97 17*
USAARMS (5)	11-98 30-25
USAIS (10)	11-117 M1-105
USAES (2)	11-127 31-106
USAINTS (3)	11-155 31-10
USATC Armor (2)	11-157 37
USATC Inf (2)	11-158 57
USASTC (2)	11-500 57-4
WRAMC (1)	

NG: State AG (3).

USAR: None.

For explanation of abbreviations used see AR 320-50

Changes in force: C 2 and C 5

***TM 11-5835-224-12
C5**

CHANGE }
No. 5 }

HEADQUARTERS,
DEPARTMENT OF THE ARMY
WASHINGTON DC, 5 *September* 1978

**Operator's and Organizational
Maintenance Manual**

**CODER-BURST TRANSMISSION
GROUP AN/GRA-71
(NSN 5820-00-056-6860)**

TM 11 5835-224-12, 27 May 1964, is changed as follows:

Title is changed as shown above.

Page 2. Table of contents. Delete the second line.

Page 4. Paragraph A, change title to read: "Indexes of Publications."

Paragraphs B, C, and D are superseded as follows:

B. Forms and Records

a. *Reports of Maintenance and Unsatisfactory Equipment.* Maintenance forms, records, and re-

*** This change supersedes C 3, 2 June 1970 and C 4, 31 August 1973**

ports which are to be used by maintenance personnel at all maintenance levels are listed in and prescribed by TM 38-750.

b. Report of Packaging and Handling Deficiencies. Fill out and forward DD Form 6 (Packaging Improvement Report) as prescribed in AR 700-58/NAVSUPINST 4030.29/AFR 71-13/MCO P4030.29A, and DLAR 4145.8.

c. Discrepancy in Shipment Report (DISREP) (SF 361). Fill out and forward Discrepancy in Shipment Report (DISREP) (SF 361) as prescribed in AR 55-38/NAVSUPINST 4610.33B/AFR 75-18/MCO P4610.19C and DLAR 4500.15.

C. Reporting of Errors

The reporting of errors, omissions, and recommendations for improving this publication by the individual user is encouraged. Reports should be submitted on DA Form 2028 (Recommended Changes to Publications and Blank Forms) and forwarded direct to Commander, US Army Communications and Electronics Materiel Readiness Command, ATTN: DRSEL-ME-MQ, Fort Monmouth, NJ 07703.

C.1. Reporting Equipment Improvement Recommendations (EIR)

EIR's will be prepared using SF 368 (Quality Deficiency Report). Instructions for preparing EIR's are provided in TM 38750, The Army Maintenance management System. EIR's should be mailed direct to Commander, US Army Communications and Elec-

tronics Materiel Readiness Command, ATTN: DRSEL-ME-MQ, Fort Monmouth, NJ 07703. A reply will be furnished direct to you.

D. Items Comprising an Operable Coder-Burst Transmission Group AN/GRA-71 (NSN 5820-00-056-6856)

<i>NSN</i>	<i>Qty</i>	<i>Item</i>	<i>Fig.No.</i>
5820-00-056-6860	1	Adapter, Keyer MX-4498/ GRA-71(KA-3)	1-6
	1	Coder, Tape MX-4495/ GRA-71 (CO-3B)	1-3
	1	Coder, Tape MX-4496/ GRA-71 (CO/B-8) ^a	1-2
	1	Keyer KY-468/GRA-71 (KE-8B)	1-4
5820-00-056-6857	2	Magazine, Recording Tape MA-9/GRA-71 (CA-3B)	1-5

^a Includes Dial Character (NSN 5820-00-920-5429), and Dial Character (NSN 5820-00-920-5430).

Page 9, paragraph 1.2.2. The last four lines are superseded as follows: "There must be one space between each character and three spaces between each word. Therefore, after each character depress the SPACE key once. If the character is the last letter in a word, depress the SPACE key three times."

Page 20, paragraph 2.2.2, *Step 6*. The last line is changed to read: "the SPACE key three times."

Page 22, paragraph 2.3. Add the following CAUTION after *Step f*.

CAUTION

When the AN/GRA-71 components are stowed in the carrying case and the cables have been secured by the retainer clamps, place the cover on the carrying case so that the rubber pad on the inside of the cover is over the component area and not over the cables and retainer clamps. This will prevent the clamps from being broken by placing the cover on incorrectly.

Page 26, paragraph 2.5 is deleted in its entirety.

Page 28. Delete figure 25.

Page 42, paragraph 3.2. The last sentence is superseded as follows: "With the CO-3B Coder, there must be one space between each character and three spaces between each word. Therefore, after each character depress the SPACE key once. If the character is the last letter in a word, depress the SPACE key three times.

Page 73, appendix A. TM 38-750 is changed to read: "The Army Maintenance Management System (TAMMS)."

Appendix B is deleted in its entirety.

Appendix C is superseded as follows:

APPENDIX C MAINTENANCE ALLOCATION

Section I. INTRODUCTION

C-1. General

This appendix provides a summary of the maintenance operations for AN/GRA-71. It authorizes categories of maintenance for specific maintenance functions on repairable items and components and the tools and equipment required to perform each function. This appendix may be used as an aid in planning maintenance operations.

C-2. Maintenance Function.

Maintenance functions will be limited to and defined as follows:

a. Inspect. To determine the serviceability of an item by comparing its physical, mechanical, and/or electrical characteristics with established standards through examination.

b. Test. To verify serviceability and to detect incipient failure by measuring the mechanical or electrical characteristics of an item and comparing those characteristics with prescribed standards.

c. Service. Operations required periodically to keep an item in proper operating condition, i.e., to clean (decontaminate), to preserve, to drain, to

paint, or to replenish fuel, lubricants, hydraulic fluids, or compressed air supplies.

d. Adjust. To maintain, within prescribed limits, by bringing into proper or exact position, or by setting the operating characteristics to the specified parameters.

e. Align. To adjust specified variable elements of an item to bring about optimum or desired performance.

f. Calibrate. To determine and cause corrections to be made or to be adjusted on instruments or test measuring and diagnostic equipments used in precision measurement. Consists of comparisons of two instruments, one of which is a certified standard of known accuracy, to detect and adjust any discrepancy in the accuracy of the instrument being compared.

g. Install. The act of emplacing, seating, or fixing into position an item, part, module (component or assembly) in a manner to allow the proper functioning of the equipment or system.

h. Replace. The act of substituting a serviceable like type part, subassembly, or module (component or assembly) for an unserviceable counterpart.

i. Repair. The application of maintenance services (inspect, test, service, adjust, align, calibrate, replace) or other maintenance actions (welding, grinding, riveting, straightening, facing, re-machining, or resurfacing) to restore serviceability to an item by correcting specific damage, fault, malfunction, or failure in a part, subassembly,

module (component or assembly), end item, or system.

j. Overhaul. That maintenance effort (service/action) necessary to restore an item to a completely serviceable/operational condition as prescribed by maintenance standards (i.e., DMWR) in appropriate technical publications. Overhaul is normally the highest degree of maintenance performed by the Army. Overhaul does not normally return an item to like new condition.

k. Rebuild. Consists of those services/actions necessary for the restoration of unserviceable equipment to a like new condition in accordance with original manufacturing standards. Rebuild is the highest degree of materiel maintenance applied to Army equipment. The rebuild operation includes the act of returning to zero those age measurements (hours, miles, etc.) considered in classifying Army equipments/components.

C-3. Column Entries.

a. Column 1, Group Number. Column 1 lists group numbers, the purpose of which is to identify components, assemblies, subassemblies, and modules with the next higher assembly.

b. Column 2, Component/Assembly. Column 2 contains the noun names of components, assemblies, subassemblies, and modules for which maintenance is authorized.

c. Column 3, Maintenance Functions. Column 3 lists the functions to be performed on the item

listed in column 2. When items are listed without maintenance functions, it is solely for purpose of having the group numbers in the MAC and RPSTL coincide.

d. Column 4, Maintenance Category. Column 4 specifies, by the listing of a "worktime" figure in the appropriate subcolumn(s), the lowest level of maintenance authorized to perform the function listed in column 3. This figure represents the active time required to perform that maintenance function at the indicated category of maintenance. If the number or complexity of the tasks within the listed maintenance function vary at different maintenance categories, appropriate "worktime" figures will be shown for each category. The number of task-hours specified by the "worktime" figure represents the average time required to restore an item (assembly, subassembly, component, module, end item or system) to a serviceable condition under typical field operating conditions. This time includes preparation time, troubleshooting time, and quality assurance/quality control time in addition to the time required- to perform the specific tasks identified for the maintenance functions authorized in the maintenance allocation chart. Subcolumns of column, 4 are as follows:

- C - Operator/Crew
- O - Organizational
- F - Direct Support
- H - General Support
- D - Depot

e. *Column 5, Tools and Equipment.* Column 5 specifies by code, those common tool sets (not individual tools) and special tools, test, and support equipment required to perform the designated function.

f. *Column 6, Remarks.* Column 6 contains an alphabetic code which leads to the remark in section IV, Remarks, which is pertinent- to the item opposite the particular code.

C-4. Tool and Test Equipment Requirements (Sec III).

a. *Tool or Test Equipment Reference Code.* The numbers in this column coincide with the numbers used in the tools and equipment column of the MAC. The numbers indicate the applicable tool or test equipment for the maintenance functions.

b. *Maintenance Category.* The codes in this column indicate maintenance category allocated the tool or test equipment.

c. *Nomenclature.* This column lists the noun name and nomenclature of the tools and test equipment required to perform the maintenance functions.

d. *National/NATO Stock Number.* This column lists the National/NATO stock number of the specific tool or test equipment.

e. *Tool Number.* This column lists the manufacturer's part number of the tool followed by the Federal Supply Code for manufacturers (5-digit) in Parentheses.

C-5. Remarks (Sec IV).

a. *Reference Code.* This code refers to the appropriate item in section II, column 6.

b. *Remarks.* This column provides the required explanatory information necessary to clarify items appearing in section II.

**SECTION II. MAINTENANCE ALLOCATION CHART
FOR
CODER-BURST TRANSMISSION GROUP AN/GRA-71
(Continued)**

(1) GROUP NUMBER	(2) COMPONENT ASSEMBLY	(3) MAINTENANCE FUNCTION	(4) MAINTENANCE CATEGORY					(5) TOOLS AND EQUIPT.	(6) REMARKS
			C	O	F	H	D		
00	CODER-BURST TRANSMISSION GROUP AN/GRA-71	Inspect		0.5	1.0			9	A
		Inspect		0.5	1.0			9	B
		Service			1.0			9	C
		Service			1.0			3,9	D
		Test			1.0			8	E
		Test			1.0			9	J
		Test				4.0		8	
		Adjust			1.5				
		Align				0.6			A
		Repair			0.5		2.0		9
01	ADAPTER, KEYER WX-4488/GRA-71 (KA-3 KEYER)	Repair					4.5	9	C
		Overhaul						3,9	D
		Inspect		0.1	0.2			9	E
		Inspect		0.1	0.2			2,3,4,6	J
		Service		0.1	0.2			7,8	
		Service			0.2			8	A
		Test			1.0			8	B
		Repair			0.5			8	C
		Repair					1.5		D
		Repair						9	E
02	MAGAZINE, RECORDING TAPE MA-8/GRA-71 (CA-3B CARTRIDGE)	Inspect		0.1	0.2			9	A
		Inspect		0.1	0.2			9	B
		Service			0.2			3,9	C
		Service			0.2			8	D
		Test			0.5			8	E
Repair					1.5				

**SECTION II. MAINTENANCE ALLOCATION CHART
FOR
CODER-BURST TRANSMISSION GROUP AN/GRA-71
(Continued)**

(1) GROUP NUMBER	(2) COMPONENT ASSEMBLY	(3) MAINTENANCE FUNCTION	(4) MAINTENANCE CATEGORY				(5) TOOLS AND EQUIPT.	(6) REMARKS
			C	O	F	D		
03	CODER, TAPE MX-4495/GRA-71 (CO-B8 CODER)	Inspect	0.1	0.2			9	A
		Inspect Service	0.1	0.2			9	B
		Service		1.2			3,9	C
		Test		2.0			8	D
		Adjust Repair		0.3		2.5	9	E
04	KEYER KY-468/GRA-71 (KE-8B KEYER)	Repair				2.5	8	J
		Inspect	0.1	0.2			9	A
		Inspect Service	0.1	0.2			9	B
		Service		0.2			9	C
		Test		1.5			3,9	D
05	CODER, TAPE MX-4495/GRA-71 (CO-3B)	Repair		0.5			9	E
		Test		2.0			2,3,4,6	J
		Adjust		1.2			7,8	I
		Align Repair		0.6		3.0	8	
		Inspect	0.1	0.2			9	A
		Inspect Service	0.1	0.2			9	B
		Service		0.2			9	C
		Test		1.0			3,9	D
		Adjust		1.2		2.5	8	E
		Repair					8	

**SECTION III. TOOL AND TEST EQUIPMENT REQUIREMENTS
FOR**

CODER-BURST TRANSMISSION GROUP AN/GRA-71

TOOL OR TEST EQUIPMENT REF CODE	MAINTENANCE CATEGORY	NOMENCLATURE	NATIONAL NATO STOCK NUMBER	TOOL NUMBER
1	F, H, D	CODE RECORDER RD-60/U	5805-00-164-7323	
2	D	TEST SET, RADIO AN/USM-26/A	6625-00-543-1356	
3	F, D	MULTIMETER TS-352B/U	6625-00-242-5023	
4	D	OSCILLOSCOPE AN/USM-140A	6625-00-987-6603	
5	F, D	TEST SET, ELECTRON TUBE TV-7/U	6625-00-376-4939	
6	F, D	TEST SET, TRANSISTOR TS-1836	6625-00-893-2628	
7	D	TIME-MARK GENERATOR AN/USM-108	6625-00-987-9564	
8	F, D	TOOL KIT, ELECTRONIC EQUIPMENT TK-100/G	5180-00-605-0079	
9	F	TOOL KIT, ELECTRONIC EQUIPMENT TK-105/G	5180-00-610-8177	

SECTION IV. REMARKS

REFERENCE CODE	REMARKS
A	Exterior mechanical and visual inspection,
B	Interior mechanical and visual inspection.
C	Exterior cleaning.
D	Interior cleaning and lubrication.
E	Mechanical and electrical troubleshooting.
F	Repair by replacement of components: MX-4496/GRA-71, MX-4495/GRA-71, KY-468/GRA-71, MA-9/GRA-71, and MX-4498/GRA-71.
G	Mechanical troubleshooting.
H	Repair by replacement of magnetic tape and authorized parts.
I	IDY frequency and waveshape, dot, dash, and space duration; dot frequency; erase function.
J	Repair by authorized parts replacement.
K	Check for tape reproduction exactness after tape replacement.

By Order of the Secretary of the Army:

BERNARD W. ROGERS
General, United States Army
Chief of Staff

Official:

J. C. PENNINGTON
Brigadier General, United States Army
The Adjutant General

Distribution:

To be distributed in accordance with DA Form 12-51, operator maintenance requirements for ANGRA-71.

This manual contains information copyrighted and owned by Stenographic Machines, Inc., 8040 North Ridgewas Avenue, Skokie, ILL.

TM 11-5835-224-12

TECHNICAL MANUAL

No. 11-5835-224-12



HEADQUARTERS
DEPARTMENT OF THE ARMY
WASHINGTON, D.C., 27 May 1984

**Operator and Organizational Maintenance
Manual
CODER-BURST TRANSMISSION GROUP
AN/GRA-71**

	Page
Preface.....	4
1.0 GENERAL INFORMATION	
1.1 Introduction.....	6
1.2 Purpose and Description.....	6
1.2.1 CO/B-8 Coder.....	6
1.2.2 CO-3B Coder.....	8
1.2.3 KE-8B Keyer.....	9
1.2.4 CA-3B Cartridge.....	12
1.2.5 KA-3 Keyer Adapter.....	13
2.0 OPERATING INSTRUCTIONS	
2.1 General Instructions.....	14
2.1.1 CO/B-8 Coder.....	14
2.1.2 CO-3B Coder.....	15
2.1.3 KE-8B Coder.....	15
2.1.4 CA-3B Cartridge.....	15
2.2 Message Recording.....	16
2.2.1 CO/B-8 Coder message recording.....	16
2.2.2 CO-3B Coder message recording.....	19
2.3 Message Transmission.....	20

	Page
2.4 Message Erasing.....	26
2.5 Tape Replacement.....	26
3.0 THEORY OF OPERATION	
3.1 General Theory.....	29
3.1.1 CO/B-8 Coder.....	29
3.1.2 CO-3B Coder.....	29
3.1.3 KE-8B Keyer.....	30
3.1.4 CA-3B Cartridge.....	30
3.1.5 KA-3 Keyer.....	30
3.2 Morse Code structure.....	31
4.0 MAINTENANCE	
4.1 Introduction.....	43
4.2 Operator's Maintenance.....	43
4.2.1 Scope of operator's Maintenance.....	43
4.2.2 Preventive maintenance.....	43
4.2.3 Preventive maintenance checks and services.....	44
4.2.4 Daily preventive maintenance checks and services chart.....	46
4.2.5 Weekly preventive maintenance checks and services chart.....	49
4.2.6 Cleaning.....	52
4.3 Organizational Maintenance	
4.3.1 Scope of organizational maintenance.....	52
4.3.2 Tools and materials required.....	53
4.3.3 Organizational preventive maintenance.....	53
4.3.4 Quarterly maintenance.....	54
4.3.5 Quarterly preventive maintenance checks and services chart.....	55
4.3.6 Cleaning and touchup painting instructions.....	60
APPENDIX. REFERENCES.....	73

Note. For reading convenience, the following short form equipment nomenclatures are used throughout this manual.

1. Coder, Tape MX-4496/GRA-71 is termed CO/ B-8 Coder.
2. Coder, Tape MX-4495/GRA-71 is termed CO- 3B Coder.
3. Keyer KY-468/GRA-71 is termed KE-8B Keyer.
4. Magazine, Recording Tape MA-9/GRA-71 is termed CA-3B Cartridge.
5. Adapter, Keyer MX-4498/GRA-71 is termed KA-3 Keyer Adapter.

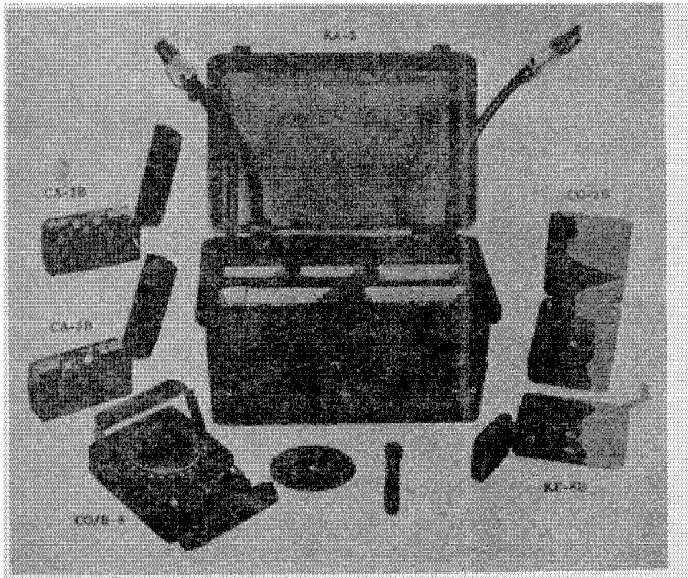

Figure 1-1. AN/GRA-71 Coder-Burst transmission group components.

PREFACE

A. Index of Publications

Refer to the latest issue of DA Pam 310 4 to determine whether there are new editions, changes, or additional publications pertaining to the equipment. DA Pam 3104 is an index of current technical manuals, technical bulletins, supply manuals (types 4, 6, 7, 8, and 9), supply bulletins, lubrication orders, and modification work orders which are available through publications supply channels. The index lists the individual parts (-10, -20, -5, etc.) and the latest changes to and revisions of each equipment publication.

Forms and Records

Reports of Maintenance- and Unsatisfactory Equipment. Use equipment forms and records in accordance with instructions in TM 38750.

Report of Damaged or Improper Shipment. Fill out and forward DD Form 6 (Report of Damaged or Improper Shipment) as prescribed in AR 700-58 (Army), NAVSANDA Publication 378 (Navy), and AFR 71-4 (Air Force).

Reporting of Equipment Manual Improvements. The direct reporting by the individual user of errors, omissions, and recommendations for improving this manual is authorized and encouraged. DA Form 2028 (Recommended changes to DA technical manual parts lists or supply manual 7, 8, or 9) will be used for reporting these

improvements. This form will be completed in triplicate using pencil, pen, or typewriter. The original and one copy will be forwarded direct to Commanding Officer, U.S. Army Electronics Materiel Support Agency, ATTN: SELMS-MP, Fort Monmouth, N. J. 07703. One information copy will be furnished to the individual's immediate supervisor (officer, noncommissioned officer, supervisor, etc).

1.0 GENERAL INFORMATION

1.1 Introduction

This manual is supplied as supporting literature for the AN/GRA-71 Coder-Burst Transmission Group components shown in Figure 1-1. Instructions for operating and maintaining these components are included in the manual. Preventive maintenance and limited corrective maintenance required of the operator to keep the equipment in dependable operating condition are provided in the maintenance section. Mechanical and electrical principles of operation are presented in the theory of operation section to assist the operator in understanding the equipment and as a prerequisite to basic troubleshooting.

1.2 Purpose and Description

1.2.1 *CO/B-8 Coder (MX-4496/GRA-71)*. Essentially, the CO/B-8 Coder (fig. 1-2) is an electromechanical Morse code generator that enables an operator to record messages in a CA-3B Cartridge. The purpose of the CO/B-8 Coder is to generate magnetic impulse trains, corresponding to Morse code patterns, for subsequent recording on magnetic recording tape.

In this capacity, a mechanical coding system and an electrical impulse generating system are employed in conjunction with each other to generate a Morse code structure. Briefly, the mechanical coding system drives the electrical impulse

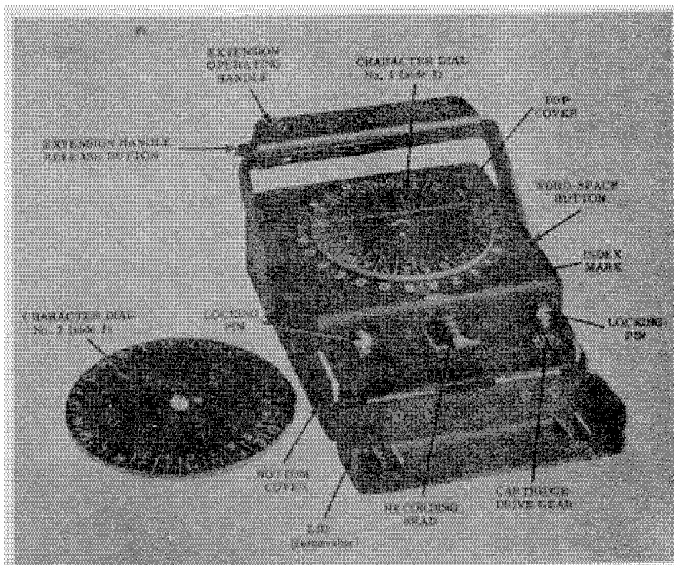

Figure 1-2. CO/B-8 Coder.

generating system to form a Morse-encoded magnetic impulse train for each character on the coder character dial. This mechanical coding system automatically generates each impulse to form either a dot or dash, and automatically produces the correct number of dots and dashes in proper sequence to form a Morse code pattern of magnetic impulses for each character.

Word spacing is also a function of the mechanical coding system. Spaces between one word and the next are created by depressing the WORD-SPACE button on the coder housing.

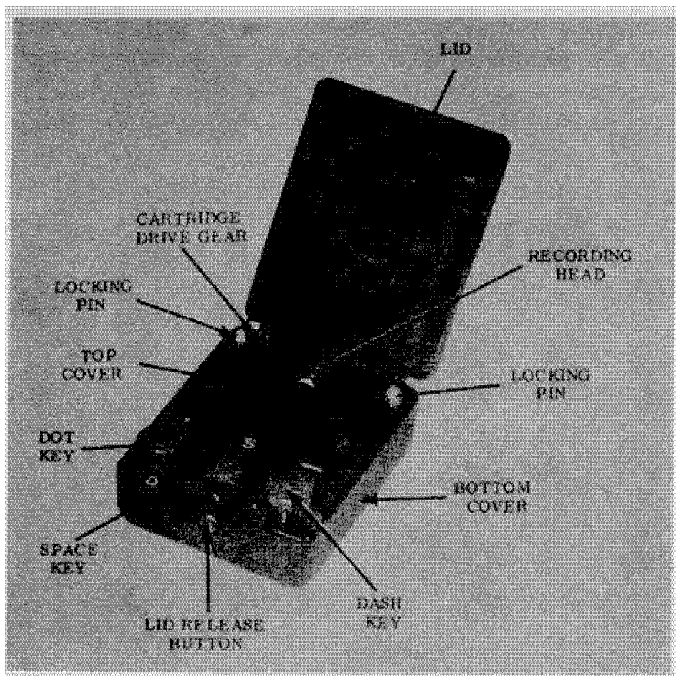

Figure 1-3. CO/3B Coder.

1.2.2 CO-3B Coder (MX-4495/GRA-71). The CO-3B Coder (fig. 1-3), like the CO/B8, is also an electromechanical Morse code generator that enables an operator to record coded messages in a CA-3B Cartridge. Essentially, the purpose of the CO-3B Coder is the same as the CO/B8: to generate magnetic impulses for subsequent recording on magnetic recording tape.

The CO-3B Coder, however, is somewhat less

automatic than the CO/B-8 in that each dot and dash element of a character is generated and recorded individually by way of the keyboard. Briefly, the DOT and DASH keys drive an electrical impulse generating system which automatically generates an impulse to form either a dot or dash element. The DOT and DASH keys also drive a spacing mechanism which automatically provides the correct amount of space after each dot and dash element.

Spaces between characters are created by depressing the SPACE key once. Spaces between two-s are created by depressing the SPACE key*twice*.

1.2.3 *KE8B Keyer (KY-468/GRA-71)*. The purpose of the KE-8B Keyer (fig. 1-4) is to convert tape-recorded, Morse-encoded characters into equivalent electrical impulses for "keying" an associated transmitter. Also associated with the KE-8B is the CA-3B Cartridge. The CA-B Cartridge, containing magnetic impulses recorded in it by either the CO/B-8 or CO-3B Coder, locks onto the KE-8B Keyer- to enable tape reading for subsequent keying of 'the associated transmitter by way of the KA-3 Keyer Adapter component.

Internally, the KE-8B Keyer contains a spring motor to drive the CA-3B Cartridge and pull the magnetic tape across the reading head. Also included is electronic circuitry for converting the prerecorded impulses on the tape into properly

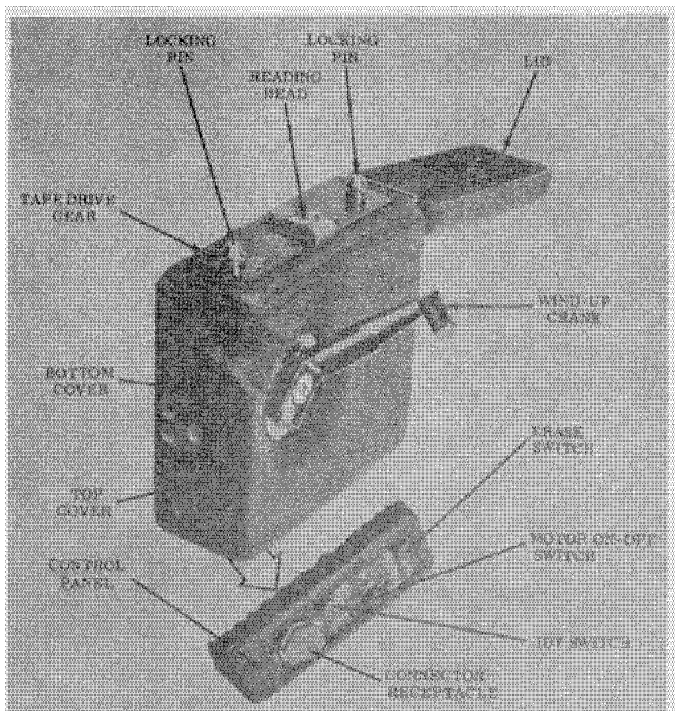

Figure 1-4. KE-8B Keyer

spaced Morse signals for transmitter keying. The KE-8B Keyer includes an IDY function for sending a continuous train of impulses at the rate of 300 words per minute), and a provision for erasing CA-3B Cartridges. Required operating power is obtained from the KA-3 Keyer Adapter cable which is plugged into the KE-8B connector.

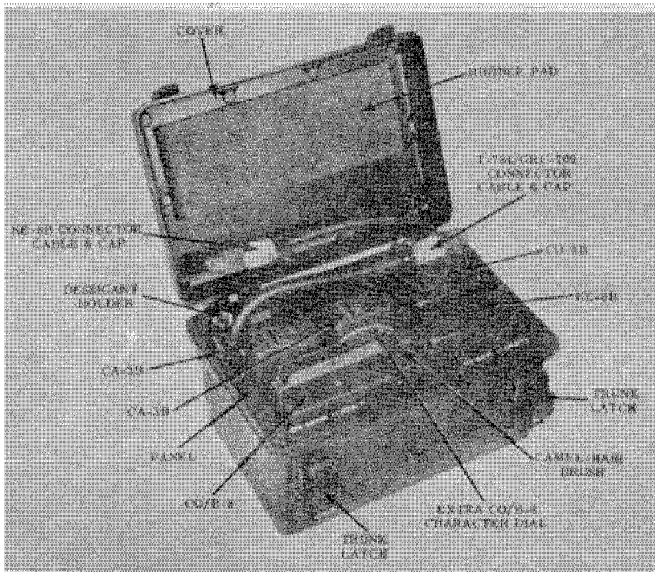

Figure 1-6. KA-3 Keyer Adapter.

1.2.4 CA-B Cartridge (MA-9/GRA-71). Essentially, the CA-B Cartridge (fig. 1-5) is a mechanical device consisting of a miniature tape transport and magnetic recording tape.

The purpose of the CA-B Cartridge is to supply magnetic tape to the CO/B8 and CO-3B Coders so that magnetic impulses can be recorded on the tape for subsequent transmission by way of the KE-8B Keyer, KA-3 Keyer Adapter, and T-784/GRC-109 Transmitter. After transmission, messages in the CA-3B Cartridge can be erased with the KE-8B Keyer component. The

CA45B Cartridge can then be reused for recording another message. A special feature of the CA-3B is an automatic rewind function which returns the tape to its starting point whenever the cartridge is detached from either of the coders or the keyer.

1.2.5 *KA-3 Keyer Adapter (MX-4498/GRA-71)*. The KA-3 Keyer Adapter (fig. 1-6) is a water-tight carrying case for the CO/B-8, CO3B, KE-8B, and CA-3B components. Within the KA-3 are rubber cushioned compartments for two (2) CA-3B Cartridges, one (1) KE-78B Keyer, one (1) COTB Coder, one (1) CO/B-8 Coder, one (1) extra character dial, and one (1) camel-hair cleaning brush. Rubber padding on the inside of the KA-3 lid protects the components against possible abrasion and damage during transit.

Also contained in the KA-3 is electronic circuitry for supplying power to the KE-8B Keyer and for adapting the KE-8B to a T-784/GRC-109 Transmitter. The T-784/GRC-109 Transmitter is not supplied as part of the AN/GRA-71 System. Cables for interconnecting the KE-8B with the KA-3 Keyer Adapter are mounted on the KA-3 panel. They are equipped with combination pin straighteners and protective caps.

2.0 OPERATING INSTRUCTIONS

2.1 General Instructions

Although the AN/GRA-71 components are simple to operate, these instructions should be thoroughly understood by the operator before using the equipment so that accidental damage and improper use may be avoided.

2.1.1 *CO/B-8 Coder*. In general, the CO/B8 Coder is operated by rotating the CHARACTER DIAL until the desired character is positioned opposite the index mark and then pulling the OPERATING HANDLE down. The operating handle must be pulled down smoothly and evenly. It must not be snapped or jerked quickly, and must always be pulled to the stop at the end of its travel. To become accustomed to the "feel" of the operating handle, operate the CO/B-8 Coder several times without a CA-3B Cartridge attached. Open the extension handle as shown in Figure 2-1.

A new character may be selected either before the operating handle is pulled, or after its travel has been completed. The character dial moves easily from one position to the next, but must not be rotated during the downstroke of the operating handle. If the dial becomes jammed, DO NOT FORCE IT. Operate the handle again, more slowly. When the jam clears, insert two word spaces and repeat the entire group in which

the jam occurred. Forcing a jammed dial can seriously damage the CO/B-8 Coder mechanism. If the difficulty persists, consult the maintenance section of this manual.

2.1.2 *COMB Coder*. In general, the CO-SB Coder is operated by depressing the DOT, DASH, and SPACE keys in various combinations to arrive at a recorded message. Each dot or dash element must be recorded individually. After the correct sequence of dots and dashes have been recorded to form a character, then the SPACE key is depressed. To become accustomed to the "feel" of the keyboard, operate the keys several times without a CA-3B Cartridge attached.

2.1.3 *KE-8B Keyer*. Essentially, KE-8B Keyer operation consists of attaching a prerecorded CA3B Cartridge to the keyer and then allowing the recorded message to be read by the KE-8B and sent into the KA-3 Keyer Adapter to trigger the T-784/GRC-109 Transmitter.

Erasing a CA-3B Cartridge on the KE-8B is also a simple operation and consists of attaching a CA-3B to the KE-8B and then allowing the message to be erased. Erasing must be performed with the KE-8B, KA-3, and T-784/GRC-109 interconnected with power applied.

2.1.4 *CA-SB Cartridge*. The CA-3B is operated in conjunction with a CO/B-8 Coder, CO4B Coder, or KE-8B Keyer. Messages are recorded in the CA-3B by either the CO/B-8 or CO-3B

Coder. After a message is recorded in the CA-3B, it is attached to the KE-8B to be read and transmitted.

2.2 Message Recording

2.2.1 CO/B-8 Coder Message Recording. The CA-3B Cartridge will hold at least 125 five-letter words plus word spaces. The maximum word capacity varies, depending upon the number of characters per word and the message length. Because of the automatic rewind feature, the CA-3B must not be removed from the CO/B-8 until the entire message has been recorded. If it is accidentally disconnected from the CO/B-8 before message completion, erase the tape and start over.

The following procedure describes the steps necessary to record a message in the CA-3B Cartridge with a co/B-8 Coder.

Step 1. Open and remove the CO/B-8 Coder and CA-3B Cartridge LIDS by sliding them off their hinge pins. Attach a fully erased CA- 8B Cartridge onto the CO/B-8 Coder by lining up the locking pins and cartridge drive gear on the coder with the sockets (in locking plates) and tape drive gear on the CA-3B Cartridge. Gently snap the two units together.

Step 2. Place the CO/B8 Coder on a smooth, flat surface. Depress the WORD-SPACE BUTTON about 10 times to move exposed tape past the recording head.

Step 3. Rotate the CHARACTER DIAL until

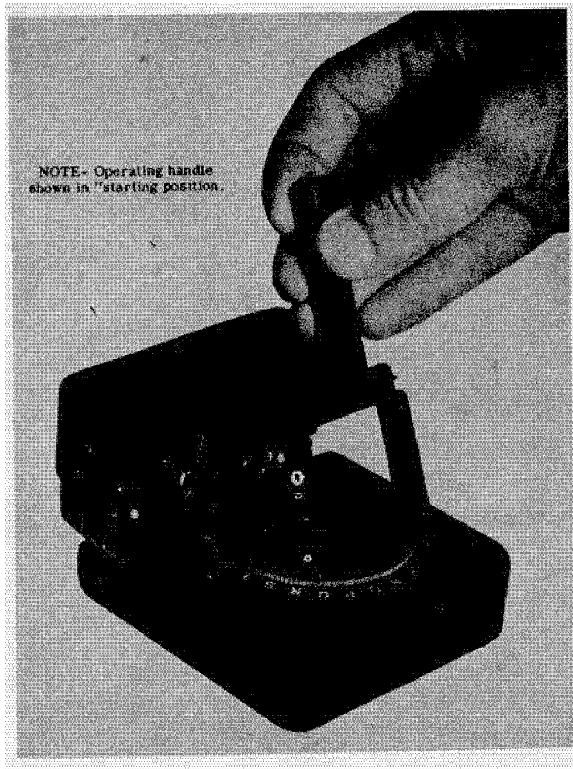

Figure 2-1. Using CO/B-8 Coder.

the first character of the message clicks into position opposite the index mark. The character dial may be rotated in either direction before or after the operating handle is pulled down.

Step 4. Depress the EXTENSION HANDLE RELEASE BUTTON and lift up the handle. Raise the HANDLE to the "starting" position shown in Figure 2-1.

Step 5. Using the thumb and three fingers as shown in Figure 2-1, grasp the HANDLE and pull it down with a firm, even stroke until it snaps against the stop at the end of its travel. DO NOT HESITATE DURING THE DOWNSTROKE. The character has now been recorded in the CA43B Cartridge.

Step 6. Select the next character of the word and repeat step 5.

Step 7. After the word has been recorded, insert a word space by firmly depressing the WORD-SPACE BUTTON once and releasing it, allowing it to return to normal position.

Step 8. Continue the procedure of steps 5, 6, and 7 until the entire message has been recorded.

Step 9. After the entire message has been recorded, detach the CA-3B Cartridge from the CO/B-8 Coder by pressing the CARTRIDGE RELEASE BUTTON inward. Lift the cartridge away from the Coder. As soon as the cartridge drive and coder drive gears separate, the cartridge begins rewinding the tape. Upon completion of rewind (about 5 seconds), the message recorded in the cartridge may be transmitted. Replace the coder LID immediately and fold the EXTENSION HANDLE

back down by depressing the release button. Replace the cartridge LID as soon as possible.

2.2.2 CO-3B Coder Message Recording. The CA-3B Cartridge will hold at least 125 five-letter words plus word spaces. The maximum word capacity varies, depending upon the number of characters per word and the message length. Because of the automatic rewind feature, the CA-3B must not be removed from the CO-3B until the entire message has been recorded. If it is accidentally disconnected from the CO-3B before message completion, erase the tape and start over.

The following procedure describes the steps necessary to record a message in the CA-3B Cartridge with a CO-3B Coder.

Step 1. Depress the LID RELEASE BUTTON and open the CO-3B Coder LID. Open and remove CA-3B Cartridge LID by sliding it off the hinge pins. Attach a fully erased CA-3B Cartridge onto the CO-3B Coder by lining up the locking pins and cartridge drive gear on the CO-3B Coder with the sockets (in locking plates) and tape drive gear on the CA-3B Cartridge. Gently snap the two units together.

Step 2. Place the CO-3B Coder on a smooth, flat surface. Place fingers on the keyboard as shown in Figure 2-2. Depress the SPACE key about 10 times to move exposed tape past the recording head.

Step 3. Depress the DOT (s) and DASH (-) keys accordingly to record a character. For ex-

ample to record the letter Q (- →-), depress the DASH key twice, depress the DOT key once, and depress the DASH key again once. The letter Q is now recorded on the tape as DASH DOT DASH.

Step 4. Depress the SPACE key once to create a space at the end of the character.

Step 5. Record the next character in the word by repeating steps 3 and 4.

Step 6. After a complete word has been recorded, insert a word space by depressing the SPACE key twice.

Step 7. Continue the procedure of steps 3, 4, 5, and 6 until the entire message has been recorded.

Step 8. After the entire message has been recorded, detach the CA-3B from the CO-3B by pressing the CARTRIDGE RELEASE BUTTON inward. Lift the cartridge away from the coder. As soon as the cartridge drive and coder gears separate, the CA-3B Cartridge begins rewinding the tape. Upon completion of rewind (about 5 seconds), the message recorded in the CA-3B Cartridge may be transmitted. Close the CO-3B Coder LID immediately. Replace the CA-3B Cartridge LID as soon as possible.

2.3 Message Transmission

The following procedure describes the steps necessary to transmit a recorded message with the KE-8B Keyer.



Figure 2-2. Using CO-3B Coder.

Step 1. Remove the KA-3 Keyer Adapter LID as shown in Figure 2-3. Grasp the trunk latches at opposite corners of the KA-3 and lift them up. (When replacing the LID, close the trunk latches at opposite corners. This prevents the rubber gasket front becoming distorted, maintaining the water-tight sea.) Open and remove the KE8B and CA4B LIDS by

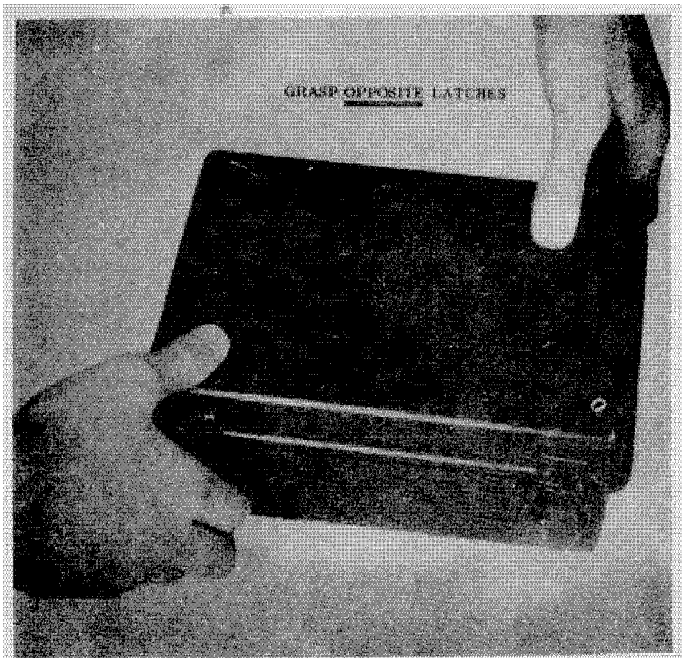

Figure 2-3. Removing KA-3 Keyer Adapter cover.

sliding them off their hinge pins. Insert the plug (P2) at the end of the keyer connector cable on the KA-3 into the CONNECTOR RECEPTACLE on the KE-8B control panel. Figure 2-4 shows the KE-8B connected to the KA4. Insert the plug (P1) at the end of the transmitter connector cable into the appropriate receptacle on the T-784/GRC-109 Transmitter.

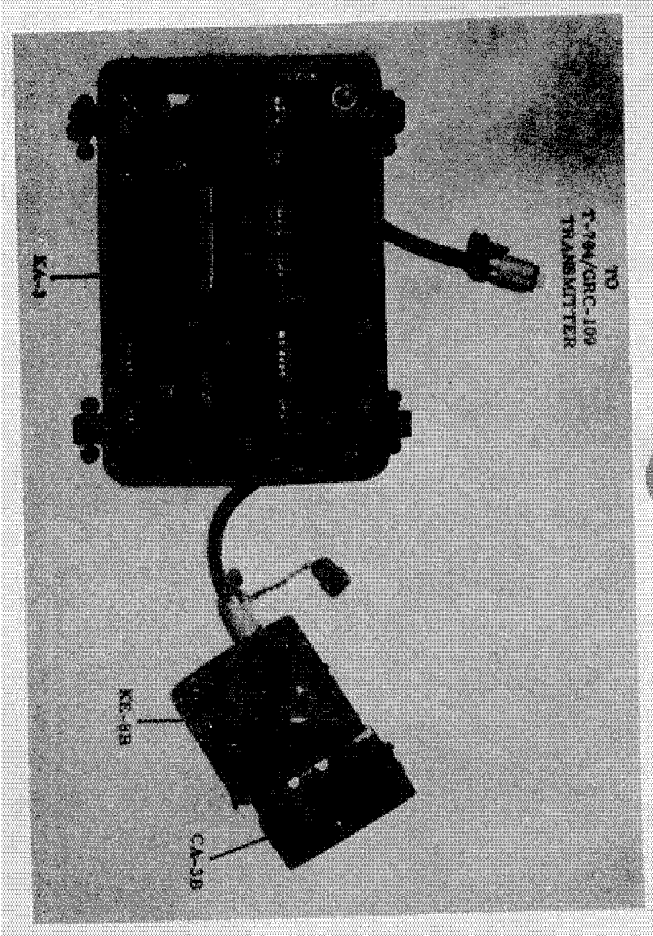

Figure 2-4. KE-3B Keyer connection to KA-3 Keyer Adapter.

Step 2. The KE-4B Keyer drive motor must be fully wound before attaching the CA-3B Cartridge and Keyer connector cable. With the MOTOR ON/OFF switch in OFF position, fold out the WIND-UP CRANK and wind it clock-wise until the TAPE DRIVE GEAR begins to rotate. A definite increase in winding resistance occurs when the motor is fully wound. About 30 turns of the crank will wind a fully run down motor.

Step 3. Attach the CA-3B Cartridge to the KE-8B by lining up the locking pins with their respective sockets on the CA-3B so that the CA-8B -and the KE-8B gears will mesh. Gently snap the two units together. The KE-8B is now ready for operation. Be sure that the T-784/GRC-109 Transmitter is switched ON and is properly adjusted.

Step 4. To transmit IDY, press the spring-loaded IDY SWITCH upward and hold it all the way up for the required IDY interval. The transmitter output, indicator will be activated during IDY transmission.

Step 5. To transmit the recorded message, slide the MOTOR ON-OFF switch to ON position. The output indicator on the transmitter should show that the message is being transmitted. When message transmission is completed, slide the MOTOR ON-OFF switch back to OFF and immediately disconnect the keyer connector cable. When the CA-3B is detached, the tape will rewind automatically. The CA-3B

may now be reattached and the message transmitted again, if necessary.

2.4 Message Erasing

The following procedure describes the steps necessary to erase a CA-3B Cartridge with the KE-8B Keyer.

Step 1. Be certain that the KE-8B Keyer drive motor is fully wound. With the MOTOR ON-OFF switch in OFF position, fold out the WIND-UP CRANK and wind it clockwise until the TAPE DRIVE GEAR begins to rotate.

Step 2. Connect the KE-8B Keyer to the KA-3 Keyer Adapter. Connect the KA-3 Keyer Adapter to the T-784/GRC-109 Transmitter and be certain that the transmitter is in operating condition.

Step 3. Attach the CA-3B to the KE-8B by lining up the locking pins with their respective sockets on the CA-3B so that the CA-3B and KE-8B gears will mesh. Gently snap the two units together. The CA-3B is now ready to be erased.

Step 4. Slide the ERASE switch up, in the direction of the arrow, and hold it in the up-ward position. Then slide the MOTOR ON-OFF to full ON position. This will lock the ERASE switch in position. Hold the MOTOR ON-OFF switch firmly against its stop until the tape has run completely through and stops.

Step 5. Return the MOTOR ON-OFF switch to OFF position, allowing the ERASE switch to return automatically to its original position.

Step 6. Disconnect the keyer adapter connector cable and then detach the CA-3B Cartridge to allow automatic rewinding. The tape is now ready for another recording.

2.5 Tape Replacement

When necessary to replace the recording tape in the CA-3B cartridge, refer to figures 1-5, 2-5, and 3-8 and proceed as follows:

Step 1. Remove the hinge pin and remove the lid of the cartridge.

Step 2. Remove the three spool cover attaching screws and remove the spool cover.

Step 3. Remove the end of the old tape from, the core of the takeup spool and allow it to dangle free.

Step 4. Remove (pull) the tape from the storage spool. Apply finger pressure to the spool to prevent automatic rewind action, then disconnect the end of the tape from the storage spool. Discard the old tape. Allow the storage spool to rewind slowly.

Step 5. Inspect the cores of both spools. Remove any residue remaining from the old tape with the camel's-hair brush provided.

Step 6. Rotate the storage spool clockwise (to increase spring pressure) until it encounters the takeup auto-stops, and hold it in this position.

Step 7. Place the shiny side of the new tape towards the core of the storage spool. Firmly attach one end of the tape to the backside of the storage spool core with a small piece of pressure-sensitive adhesive tape.

Step 8. Allow the storage spool to rewind (the tape) slowly. Control the rewind speed with finger pressure on the storage spool while maintaining sufficient tension on the tape to prevent it from wrinkling or winding up loosely. There should be about 1 inch of loose tape remaining after a complete rewind.

Step 9. Rotate the takeup spool counterclock-wise until it encounters the rewind auto-stops.

Step 10. Thread the free end of the tape over the tension idler, and over the tape guides. Be sure that the dull surface of the tape is on the outside.

Step 11. Pull out enough tape to make a complete extra turn around the core of the takeup spool (fig. 2-5). Attach the tape to the core with a short length of pressure-sensitive tape. The purpose of this extra turn is to provide a full turn of tape completely around the core of the spool when it is at rest. This insures a lasting attachment and prevents the adhesive tape from contaminating or touching the overlying layers of recording tape.

Step 12. Check the rewind action by rotating the takeup spool fully clockwise and then allowing the storage spool to rewind completely.

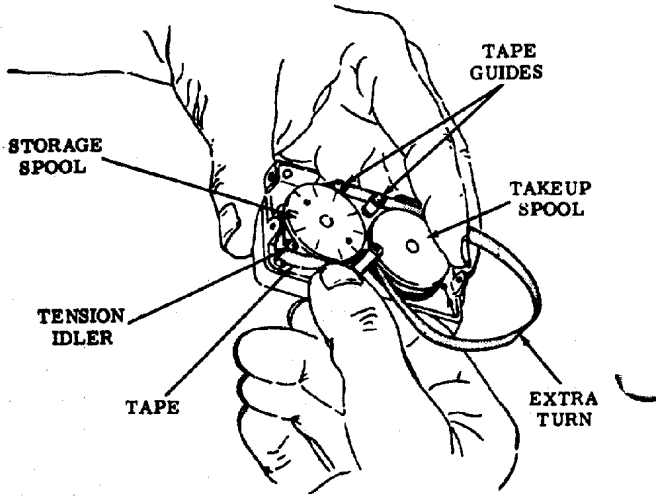

Figure 2-5. CA-3B Cartridge tape replacement.

There should be no slack during or after rewind. Replace the spool cover.

Step 13. Reassemble the cartridge and condition (polarize) the tape before using it by erasing it on the KE-8B Keyer.

3.0 THEORY OF OPERATION

3.1 General Theory

This section is presented to familiarize the operator with the operating principles of the equipment and as a prerequisite to preventive maintenance and basic troubleshooting. It consists of a summary of general theory, including Morse code structure, followed by detailed explanations of the CO/B-8 Coder, CO-3B Coder, KE-8B Keyer, CA-3B Cartridge, and the KA-3 Keyer Adapter operating principles.

3.1.1 *CO/B-8 Coder.* As mentioned, the CO/B-8 Coder enables an operator to record Morse-encoded messages on a magnetic tape contained in the CA-3B Cartridge. Actually the message is stored in two tracks on the tape in the form of precisely spaced, magnetic impulses representing Morse-encoded characters. Magnetic impulses representing dots are recorded in one track; magnetic impulses representing dashes are recorded in the other track.

3.1.2 *CO-3B Coder.* The CO-3B Coder like the CO/B-8 records in two channels in the form of precisely spaced, magnetic impulses representing Morse-encoded characters. Magnetic impulses representing dots are recorded in one track; magnetic impulses representing dashes are recorded in the other track.

3.1.3 *KE-8B Keyer*. The function of the KE-8B is to read the CA-3B Cartridge magnetic tape and to generate a perfectly spaced Morse code dot whenever a dot impulse occurs, and a perfectly spaced dash whenever a dash impulse occurs.

The KE-8B Keyer contains a spring motor to drive the CA-3B Cartridge, and electronic circuitry for converting the tape-recorded impulses into properly spaced Morse code keying signals. In addition, an IDY function for sending a continuous train of dots at 300 wpm, and an erasing function for erasing CA-3B Cartridges, are included. Required input power is 12-volts dc at a maximum current drain of 40 milliamperes. This power is supplied to the Keyer by the KA-3 Keyer Adapter. All electrical connections to the KE-8B Keyer are made through the 7-pin Amphenol connector receptacle located on the control panel.

3.1.4 *CA-3B Cartridge*. The sole function of the CA-3B Cartridge is to carry and store the magnetic tape used for recording Morse-encoded messages. The CA-3B Cartridge has a capacity of 12 1/2 feet of Minnesota Mining & Manufacturing Co., Type 428 Instrument Grade magnetic recording tape, including the "lead" portion (at the beginning) and the "residual" portion (at the end).

3.1.5 *KA-3 Keyer Adapter*. Essentially, the KA-3 Keyer Adapter connects the KE-8B Keyer output to the input of a T-784/GRC-109 Transmitter. In this capacity, the KA-3 converts the

KE-8B output keying impulses into transmitter modulation signals. Also, the KA-3 supplies 12 vdc at 50 ma to the KE-8B Keyer.

3.2 Morse Code Structure

The basic unit of measure in Morse code structure is the dot. By definition the dot is one baud long; the dash is defined as three bauds long. Spaces within characters are one baud, spaces between characters are three bauds, and spaces between words are seven bauds.

Figure 3-1 shows the relationship between impulse spacing on the tape and the corresponding Morse code message. Notice that the impulses in the dot and dash tracks are identical in width—only the amount of tape advance after each impulse differs. The code pattern for each character on CO/B-8 Coder character dial no. 1 is shown in Figure 3-2A. Figure 3-2B shows codes for character dial no. 2. These codes are shown as they appear on the magnetic tape when the tape is "developed" in Magna-See. The Magna-See "developing" procedure is described in Figure 4-12.

In a 300 word-per-minute system, such as the AN/GRA-71, the time duration of a dot is 3.3 milliseconds, and that of a dash is 10 milliseconds. Accordingly, the distance between impulses and the speed of the tape are directly related to the signaling rate. From the speed of the tape during transmission (4.5 inches per seconds) it may be

CHARACTER		CODE	TAPE APPEARANCE	CHARACTER		CODE	TAPE APPEARANCE
side 1	side 2			side 1	side 2		
A, Z	A	---...-		N, M	N	---	
B, Y	B	---...-		O, L	O	---...-	
C, X	C	---...-		P, K	P	---...-	
D, W	D	---...-		Q, J, 0	Q	---...-	
E, V	E	---...-		R, I, 9	R	..	
F, U	F	---...-		S, H, 8	S	
G, T	G	---		T, G, 7	T	---...-	
H, S	H	...		U, F, 6	U	---...-	
I, R	I	---...-		V, E, 5	V	.	
J, Q	J	---...-		W, D, 4	W	---...-	
K, P	K	---...-		X, C, 3	X	---...-	
L, O	L	---...-		Y, B, 2	Y	---...-	
M, N	M	---		Z, A, 1	Z	---	

Figure 3-2A. Code chart for CO/B-8 Coder character dial No. 1.

CHARACTER		CODE	TAPE APPEARANCE	CHARACTER		CODE	TAPE APPEARANCE
slide 1	slide 2			slide 1	slide 2		
A,1	1	••••		N	••••		
B,2	2	•••••		O	•••••		
C,3	3	••••••		P	••••••		
D,4	4	•••••••		Q	•••••••		
E,5	5	••••••••		R	••••••••		
F,6	6	•••••••••		S	•••••••••		
G,7	7	••••••••••		T	••••••••••		
H,8	8	•••••••••••		U	•••••••••••		
I,9	9	••••••••••••		V	••••••••••••		
J,0	0	•••••••••••••		W	•••••••••••••		
K		••••••••••••••		X	••••••••••~		
L		•••••••••••••••		Y	••••••••••~•		
M		••••••••••~		Z	••••••••••~••		

Figure 3-2B. Code chart for CO/B-8 Coder character dial No. 2.

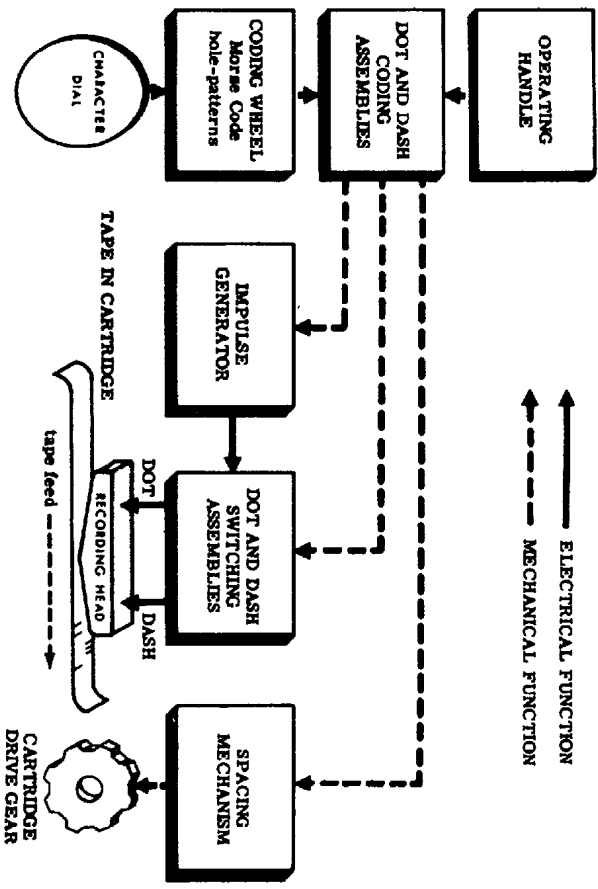

Figure 3-3. CO/B-8 Coder functional block diagram.

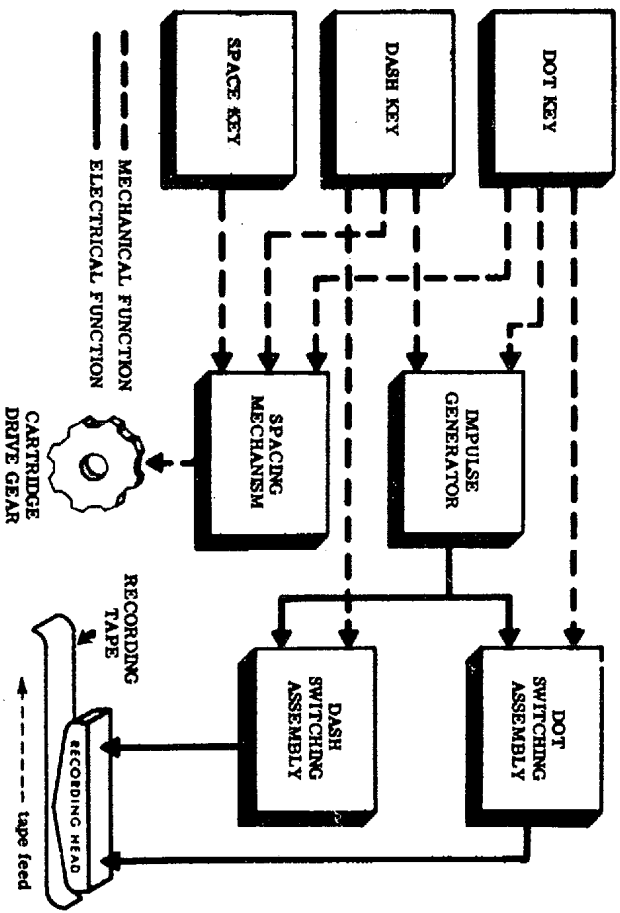

Figure 3-5. CO-3B Coder functional block diagram.

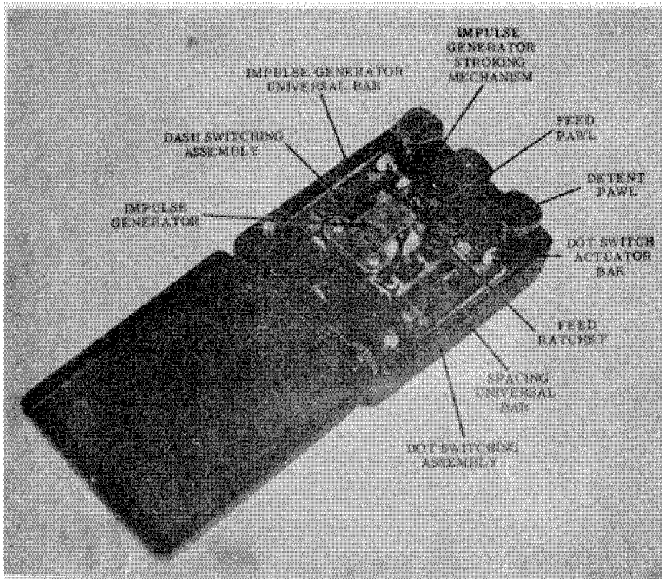

Figure 3-6. CO-3B Coder internal mechanism.

calculated that the baud length on the tape is 0.015 inches.

When a dot is to be recorded, the CO/B-8 or CO-3B Coder must place an impulse in the dot track and then advance the tape 0.030 inches or 2 baud lengths: one baud for the dot itself and one baud for the space that always follows a dot. When a dash is to be recorded, the CO/B-8 or CO-3B must place an impulse in the dash track and then advance the tape 0.060 inches or four baud lengths: three bauds for the dash itself and

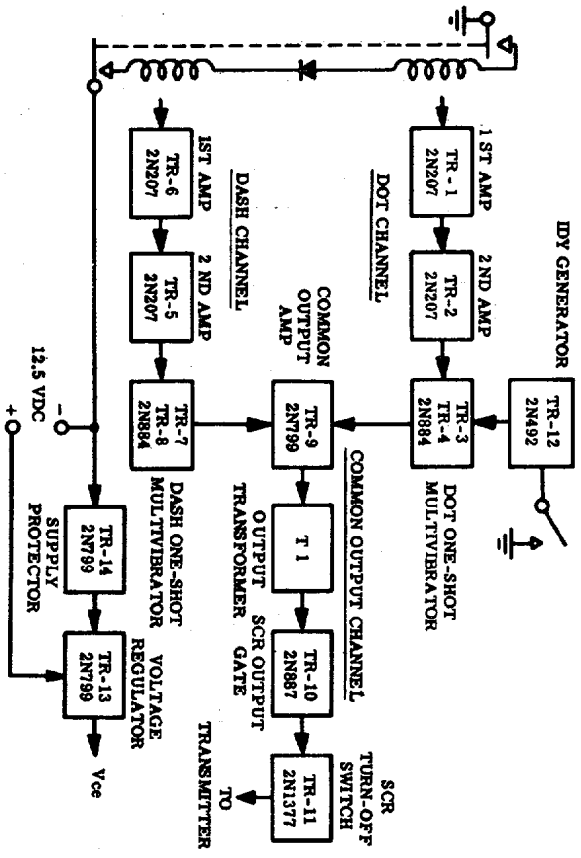

Figure 3-7. KE-8B Keyer electronics section functional block diagram.

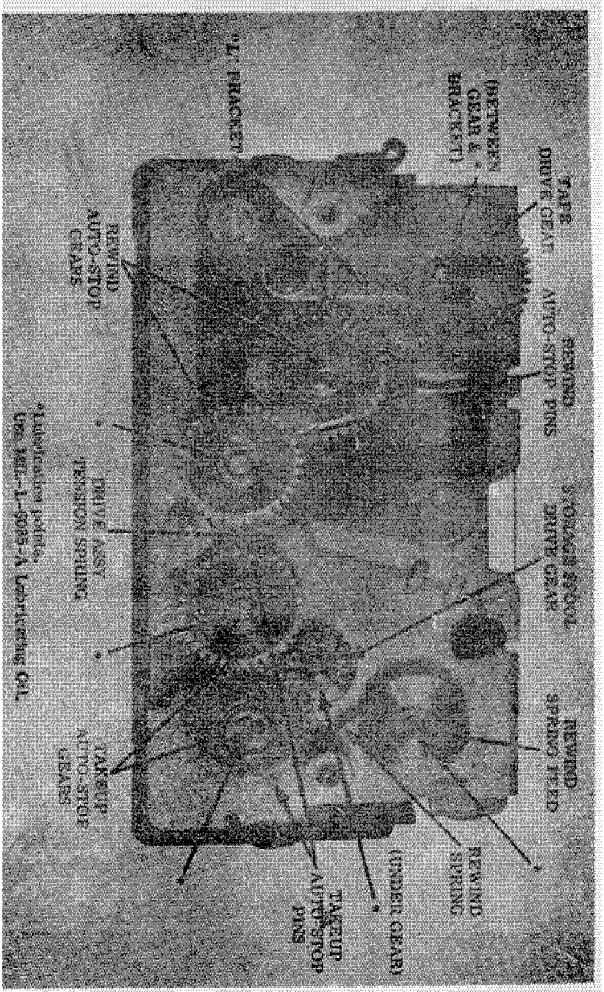

Figure 3-8. CA-3B Cartridge Internal mechanism.

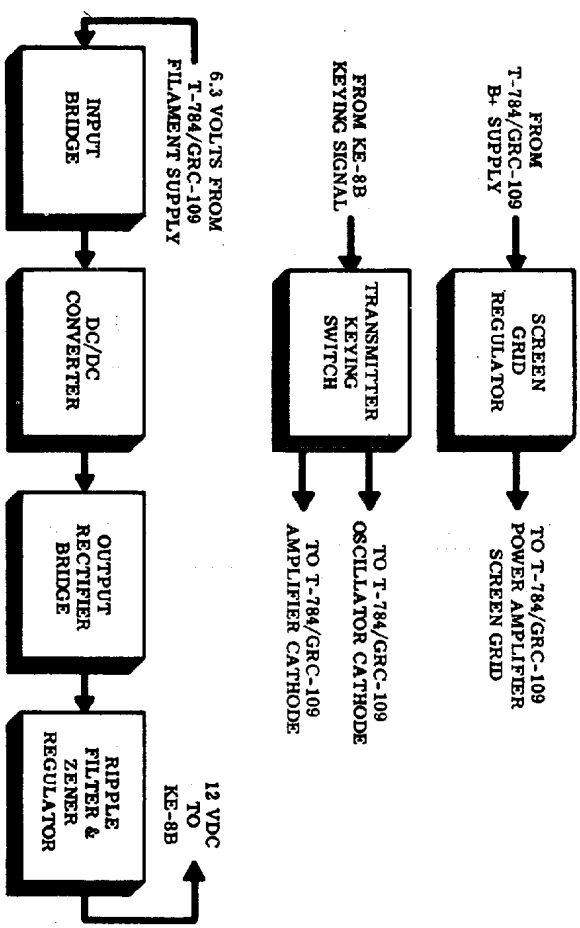

Figure 3-9. KA-3 Keyer Adapter functional block diagram

one baud for the space that always follows a dash.

At the end of each character the CO/B-8 or CO-3B Coder must insert an additional two bauds, which when added to the single baud following the last dot or dash in the character, equals the three-baud character space. Between words, depressing the CO/B8 Coder WORD-S PACE BUTTON once advances the tape an additional four bauds for a total of seven bauds between words. The CO3B Coder SPACE KEY must be depressed twice for the additional four-baud advance.

4.0 MAINTENANCE

4.1 Introduction

The AN/GRA-71 components are precision assemblies, carefully assembled and adjusted to very close tolerances at the factory. The complexities of these assemblies preclude extensive repairs in the field; accordingly no service or repairs should be attempted beyond the preventive and corrective maintenance outlined in this manual. When any procedures described in this manual fail to correct a malfunction condition, the faulty component should be returned to the factory for repairs.

4.2 Operator's Maintenance

4.2.1 *Scope of Operator's Maintenance.* The maintenance duties assigned to the operator of the AN/GRA-71 are listed below together with a reference to the paragraphs covering the specific maintenance functions. No tools or test equipment are required for performing operator's maintenance.

- a. Daily preventive maintenance checks and services (para. 4.2.4).
- b. Weekly preventive maintenance checks and services (para. 4.2.5).
- c. Cleaning (para. 4.2.6).

4.2.2 *Preventive Maintenance.* Preventive maintenance is the systematic care, servicing, and inspection of equipment to prevent the occurrence

of trouble, to reduce downtime, and to assure that the equipment is serviceable.

a. *Systematic Care.* The procedures given in paragraphs 4.2.4 through 4.2.6 cover routine systematic care and cleaning essential to proper upkeep and operation of the equipment.

b. *Preventive Maintenance Checks and Services.* The preventive maintenance checks and services charts (para. 4.2.4 and 4.2.5) outline functions to be performed at specific intervals. These checks and services are to maintain Army electronic equipment in a combat serviceable condition; that is, in good general (physical) condition and in good operating condition. To assist operators in maintaining combat serviceability, the charts indicate what to check, how to check, and what the normal conditions are; the References column lists the illustrations, paragraphs, or manuals that contain supplementary information. If the defect cannot be remedied by the operator, higher echelon maintenance or repair is required. Records and reports of these checks and services must be made in accordance with the requirements set forth in TM 38-750.

4.2.3 *Preventive Maintenance Checks and Services Periods.* Preventive maintenance checks and services of the equipment are required on a daily and weekly basis.

a. Paragraph 4.2.4 specifies the checks and services that must be accomplished daily or at

least once each week if the equipment is maintained in standby condition.

b. Paragraph 4.2.5 specifies the checks- and services that must be accomplished weekly.

4.2.4 Daily Preventive Maintenance Checks and Services Chart.

Sequence No.	Item	Procedure	References
ADAPTER, KEYER MX-4498/GRA-71			
1	Completeness.....	Inspect the equipment for completeness.....	Fig. 1-1.
2	Exterior surfaces.....	Clean the exterior surfaces of the adapter.....	Para. 4.2.6.
3	Interior surfaces.....	Remove components from the pockets in the adapter. Clean the interior surfaces of the adapter	Fig. 4-8 and para 4.2.6.
4	Connector cables, plugs, and caps	Inspect connector cables and plugs for worn insulation and bent or broken pins on the plugs. Check for presence of protective caps and keeper chains. When not in use, keep the plugs covered with the protective caps. The caps may be used as pin straighteners in the event that pins become distorted.	Fig. 1-6
5	Connector cable clamps	Inspect the connector cable clamps located on the top panel of the adapter. They should not be bent out of shape or broken.	Fig. 4-8

6	Rubber pad.....	Inspect the rubber pad attached to the inside of the cover. It should not be loose or worn. Reattach or replace as necessary.	Fig. 1-6
7	Watertight gasket.....	Examine the watertight gasket around the ease of the keyer adapter for damage or deformity. Clean the gasket, if necessary.	Para. 4.2.6.
8	Operation.....	Operate the equipment as indicated in section 2.0 of this manual. Report any unusual occurrences to higher echelon.	
9	Handles and cranks.....	Check that the operating handle and operating handle extension on the CO/B-8 Coder are not bent or broken (fig. 1-2). Check that the windup crank on the KE-8B Keyer is not deformed, stuck, or broken (fig. 1-4).	
10	Dials.....	Check that the character selector dials that are part of the CO/B-8 Coder are not deformed or binding. Also check that the printing on the dials is legible.	Fig. 1-2

Sequence No.	Item	Procedure	References
11	Switches	Check that the word-space button on the CO/B-8 Coder is not stuck or broken (fig. 1-2). Check that the dot, space, and dash keys on the CO-3B Coder are not stuck or broken (fig. 1-3). Check that the IDY, ERASE, and MOTOR ON-OFF switches on the KE-8B Keyer are not broken or loose (fig. 1-4).	
12	Covers.....	Check that the lids on the CO-3B Coder (fig. 1-3), the KE8B Keyer (fig. 1-4), and the CA-3B Cartridges (fig. 1-5), are not deformed or bent on their hinges.	
13	Gears.....	Check that the gears in the two coders (fig. 1-2, and 1-3), the two cartridges (fig. 1-5), and the keyer (fig. 1-4), are not stuck or binding.	
14	Exterior surfaces.....	Clean the exterior surfaces of the coders, the Para. 4.2.6 cartridges, and the keyer.	

4.2.5 Weekly Preventive Maintenance Checks and Services Chart

Sequence No.	Item	Procedure	References
ADAPTER, KEYER MX-4498/GRA-71			
1	Trunk latches.....	Inspect the adapter for missing, loose, broken, or bent trunk latches.	Fig. 1-6
2	Exterior surfaces.....	Inspect exterior surfaces for dents, paint chips, rust, or corrosion.	
3	Component pockets.....	Clean the component pockets.....	Para. 4.2.6 and fig. 4-8.
4	Desiccant.....	Check the color of the desiccant agent by looking through the transparent desiccant holder cap. The color should be blue; replace the desiccant agent if the color is pink. The desiccant cap is removed by pulling it out with a slight upward rotating motion. Remove the components from the pockets and invert the adapter to remove the desiccant agent. The desiccant agent may be reactivated by the accepted baking procedure which should restore	

Sequence No.	Item	Procedure	References
		the normal blue activated color. Before replacing the desiccant holder cap, remove dirt or other foreign matter that might be adhering to the rubber O-ring around the cap.	
5	Panel mounting screws and desiccant holder cap	Inspect for loose or missing panel mounting screws and holder cap	Fig. 4-8
OTHER COMPONENTS			
6	Locking devices	Inspect the locking pins and locking grasps on the coders and keyer for loose mountings and misalignment. Tighten if necessary. Inspect the locking plates on the two cartridges for stiff or tight operation.	Fig. 1-2, 1-3, 1-4, and 1-5
7	Recording and reading heads.	Clean the recording heads in the two coders and the reading head in the keyer. Use a lint-free cloth moistened with cleaning compound. Dry and polish the heads thoroughly.	Fig. 1-2, 1-3, 1-4, and para. 4.2.6.

8	Mounting hardware	Inspect for loose or missing screws in the covers of the coders, cartridges, and the keyer. Tighten the screws if necessary.	Fig. 1-2, 1-3, 1-4, and 1-5.
---	-------------------	--	------------------------------

4.2.6 *Cleaning.* Inspect the interior of the adapter, the coders, the keyer, and the magazines. The exterior surfaces should be clean and free of dust, dirt, grease, and fungus.

Warning: Compressed air is dangerous and can cause physical injury to the operator and to the equipment. Be careful in its use. Do not use compressed air to dry parts cleaned with cleaning compound.

a. Remove dust and loose dirt from large surfaces with a lint-free cloth or the camel's-hair brush provided. Remove dust and loose dirt from inaccessible places with compressed air.

Warning: Cleaning compound is flammable and its fumes are toxic. Provide adequate ventilation. Do not use cleaning compound near a flame. Do not use cleaning compound on the gasket of the adapter.

b. Grease, fungus, ground-in dirt can be removed from larger surfaces with a soft cloth dampened with cleaning compound. In restricted (small, tight) areas, grease, fungus, and ground-in-dirt can be removed with the camel's-hair brush. Moisten the brush with cleaning compound if necessary.

4.3 Organizational Maintenance

4.3.1 *Scope of Organizational Maintenance.* Paragraph 4.3 contains instructions covering organizational maintenance of the AN/GRA-71. It includes instructions for performing preventive

and periodic maintenance- services and repair functions to be performed by the organizational repairman. Organizational maintenance of the AN/GRA-7 includes

- a. Preventive maintenance (para. 4.3.3).
- b. Cleaning interiors of the components of the equipment (para. 4.3.5).
- c. Cleaning switch and relay contacts (para. 4.3.5).
- d. Lubrication (para. 4.3.5).

4.3.2 *Tools and Materials Required.* The tools and materials required for organizational maintenance of the AN/GRA-71 consist of a few small handtools, a source of compressed air, a small eye-dropper oil dispenser, and the following cleaning and lubricating materials:

- a. Cleaning compound (FSN 7930-395-9542)
- b. Cleaning cloth (soft lint-free).
- c. Lubricating oil, general purpose, preservative (PL-special).-
- d. Crocus cloth or equivalent.

4.3.3 *Organizational Preventive Maintenance.*

a. Preventive maintenance is the systematic care, inspection, and servicing of equipment to maintain it in serviceable condition, prevent breakdowns, and to assure maximum operational capability. Preventive maintenance is the responsibility of all echelons concerned with the equipment and includes the inspection, testing, and re-

pair or replacement of parts, subassemblies, or units that inspection and tests indicate would probably fail before the next scheduled periodic service. Preventive maintenance checks and services of the AN/GRA-71 equipment are made at quarterly intervals.

b. Maintenance forms and records to be used and maintained on the AN/GRA-71 are specified in TM 38750.

4.3.4 *Quarterly Maintenance.* Quarterly preventive maintenance checks and services on the equipment are required. All deficiencies and short-comings will be recorded in accordance with the requirements of TM 38750. Perform all the checks and services listed in the quarterly preventive maintenance checks and services chart (para. 4.3.5) in the sequence listed.

4.3.5 Quarterly Preventive Maintenance Checks and Services Chart.

Sequence No.	Item	Procedure	References
1	Cleaning interiors and lubrication.	<p>ADAPTER, KEVER MX-4498/GRA-71</p> <ol style="list-style-type: none"> Remove the screws identified by the asterisks in figure 4-8 and lift the panel out of the adapter. Clean the interior of the adapter; use forced air at low pressure. Be careful not to damage any components. Check wiring in adapter for frayed wires and possible shorts and opens. Replace panel. Do not over-tighten panel screws. <p>CODER, TAPE MX-4496/GRA-71</p> <ol style="list-style-type: none"> Open the lid covering the recording head and remove the lid by pulling out the hinge pins. Remove the countersunk screws at the center of the character dial. Lift the dial from the shaft and locating pin. 	<p>Fig. 4-9 and 4-10. Fig. 4-9 and 4-10. Fig. 1-2. Fig. 1-2.</p>

Sequence No.	Item	Procedure	References
		<ul style="list-style-type: none"> c. Remove the three screws from the two sides and rear of the top cover of the coder. Remove the cover. d. Clean the interior of the coder; use forced air at low pressure. Be careful not to damage any components. e. Check wiring in coder for frayed wires and possible shorts and opens. f. Lubricate the coder at points indicated in figure 4-1A and 3-4. Do not overlubricate. g. Reassemble the coder. 	Fig. 4-1A and 4-1B.
		<p>CODER, TAPE MX-4495/GRA-71</p> <ul style="list-style-type: none"> a. Open the coder lid by pressing the lid release button. b. Remove the two screws that hold the top cover of the coder. Remove the cover. c. Remove the four screws that hold the bottom cover of the coder. Remove the cover. 	Fig. 1-3. Fig. 1-3 and 3-6.

Sequence No.	Item	Procedure	References
		<p><i>d.</i> Clean the interior of the coder; use forced air at low pressure. Be careful not to damage any components.</p> <p><i>e.</i> Clean the dot and dash switching assemblies (fig. 3-6) by lightly drawing a piece of crocus cloth between- each set of contacts. When cleaning the normally open contacts, hold the contacts together gently to prevent bending or distorting the switch blades.</p> <p><i>f.</i> Reassemble the coder.</p>	Fig. 3-6.
		<p style="text-align: center;">KEYER KY-468/GRA-71</p> <p><i>a.</i> Lift the keyer lid and remove it by pulling out the hinge pin.</p> <p><i>b.</i> Remove the two screws from the right and left sides of the top cover.</p> <p><i>c.</i> Unfold the windup crank to an almost perpendicular position. Lift off the top cover and fold back the windup crank to its normal position.</p> <p><i>d.</i> Remove the four screws that hold the bottom cover. Lift out the keyer mechanism.</p>	<p>Fig. 1-4.</p> <p>Fig. 1-4.</p> <p>Fig. 1-4.</p>

Sequence No.	Item	Procedure	References
		<p><i>e.</i> Clean the interior of the keyer; use forced air at low pressure. Be careful not to damage any components. Clean the circuit boards with a camel's-hair brush slightly moistened with cleaning compound.</p> <p><i>f.</i> Inspect the circuit boards for cracks and breaks in wiring. Inspect other wiring for possible shorts and opens.</p> <p><i>g.</i> Lubricate the keyer at points indicated by asterisks in figures 4-5 and 4-6. Be careful not to over-lubricate and wipe off excess oil.</p> <p><i>h.</i> Reassemble the keyer.</p>	<p>Fig. 4-5 and para. 4.2.6.</p> <p>Fig. 4-5.</p>
		<p>MAGAZINE, RECORDING TAPE MA-9/GRA-71 (2 ea)</p> <p><i>a.</i> Remove the three screws that hold the spool cover and remove the cover.</p> <p><i>b.</i> Remove the two screws that hold the gear cover and remove the cover</p> <p>Note: If necessary to remove the recording tape, see para. 2.5.</p>	<p>Fig. 1-5.</p> <p>Fig. 1-5.</p>

Sequence No.	Item	Procedure	References
		<p>c. Clean the interior of the cartridge; use forced air at low pressure. Be careful not to damage any components and the recording tape. Remove grease by using a soft cloth dampened with cleaning compound. Be careful not to get cleaning compound on the recording tape.</p> <p>d. Lubricate the cartridge at points identified by asterisks in figure 3-8. Do not over-lubricate. Wipe off excess oil.</p> <p>e. Reassemble the cartridge.</p>	Fig. 3-4 and para. 4.2.6.
2	Publications.....	See that all publications are complete, serviceable, and current.	DA Pam 3104
3	Modifications.....	Check DA Pam 3104 to determine if new applicable MWO's have been published. All URGENT MWO's must be applied immediately. All NORMAL MWO's must be scheduled.	
4	Preservation.....	Check all surfaces for evidence of fungus. Remove rust and corrosion and spot paint bare spots.	Para. 4.3.6.

4.3.6 *Cleaning and Touchup Painting Instructions.* Clean rust and corrosion from metal surfaces by lightly sanding them with fine sandpaper. Brush two thin coats of paint on the bare metal to protect it from further corrosion. Refer to the applicable cleaning and refinishing practices specified in TM 9-213.

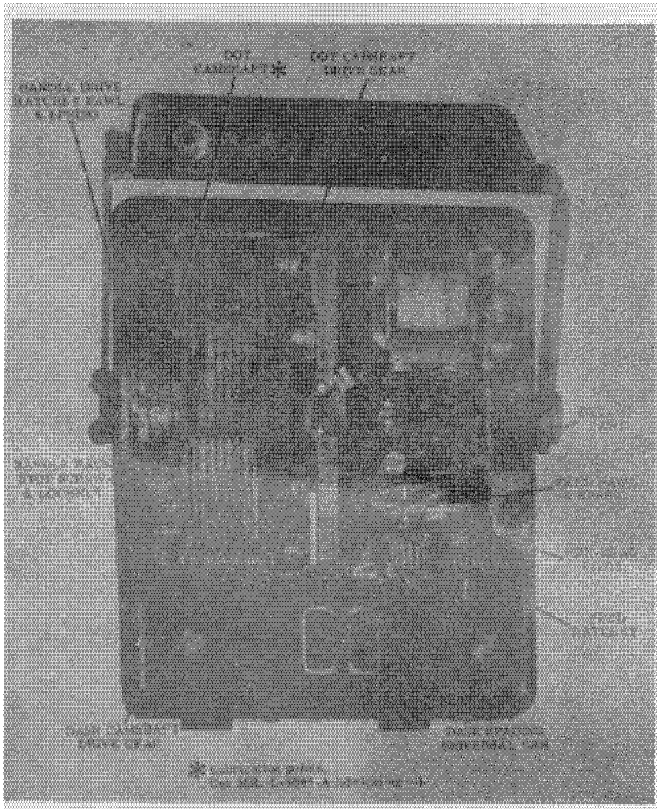

Figure 4-1A. CO/B-3 Coder with top cover removed.

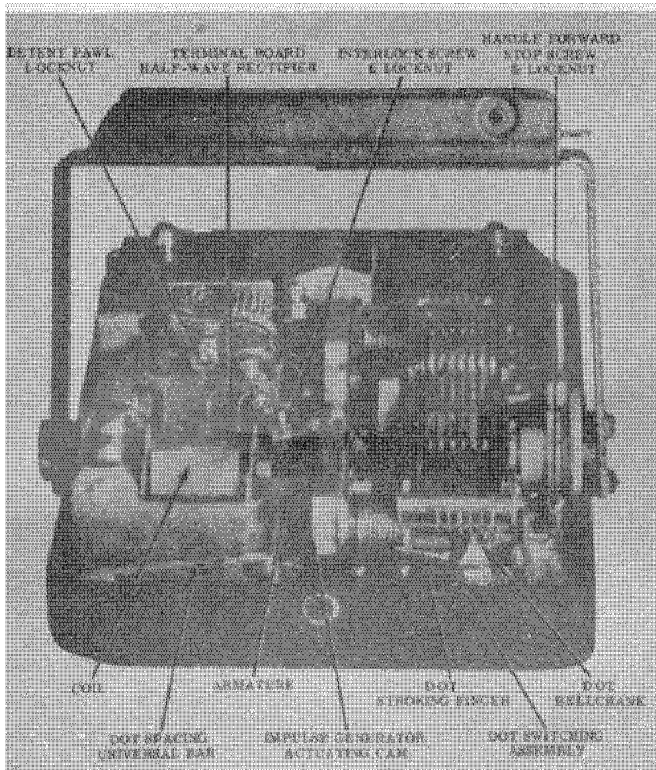

Figure 4-1B. CO/B-3 Coder with top cover removed.

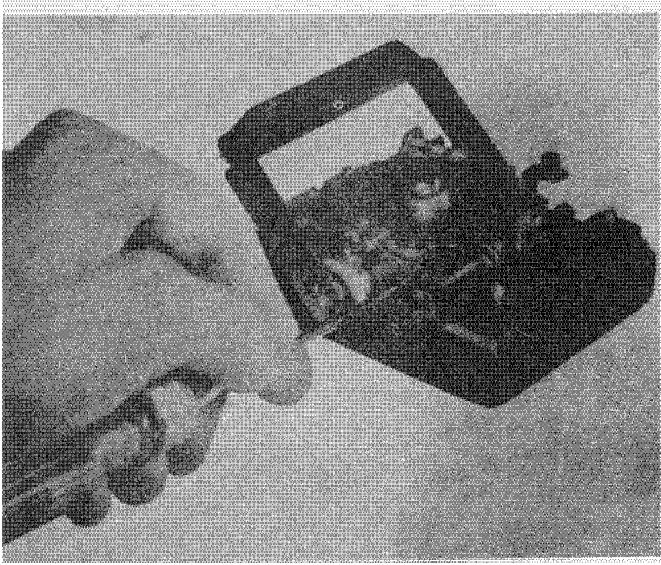

Figure 4-2. Screwdriver rotation of CO/B-8 Coder dash camshaft.

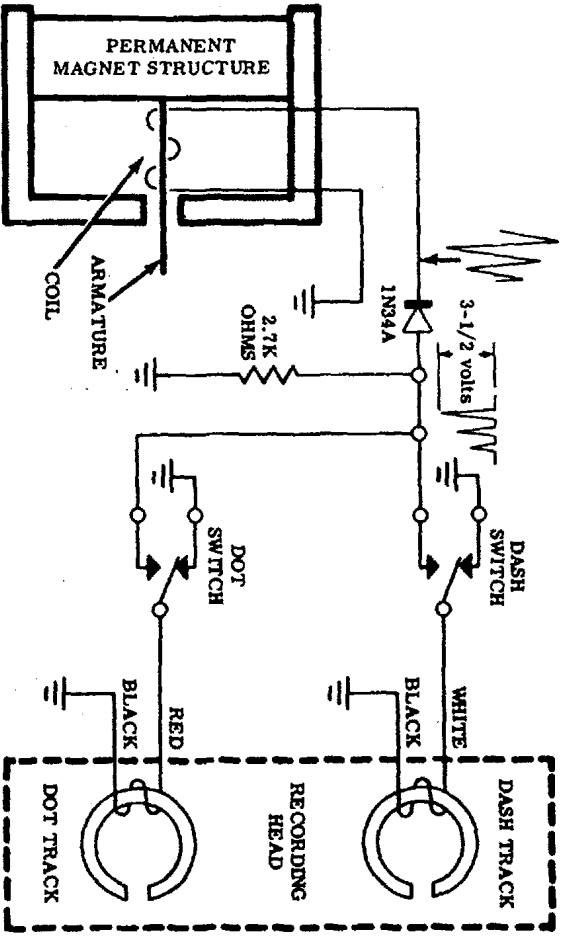

Figure 4-3. Impulse generator diagram for CO/B-8 and CO-3B Coders.

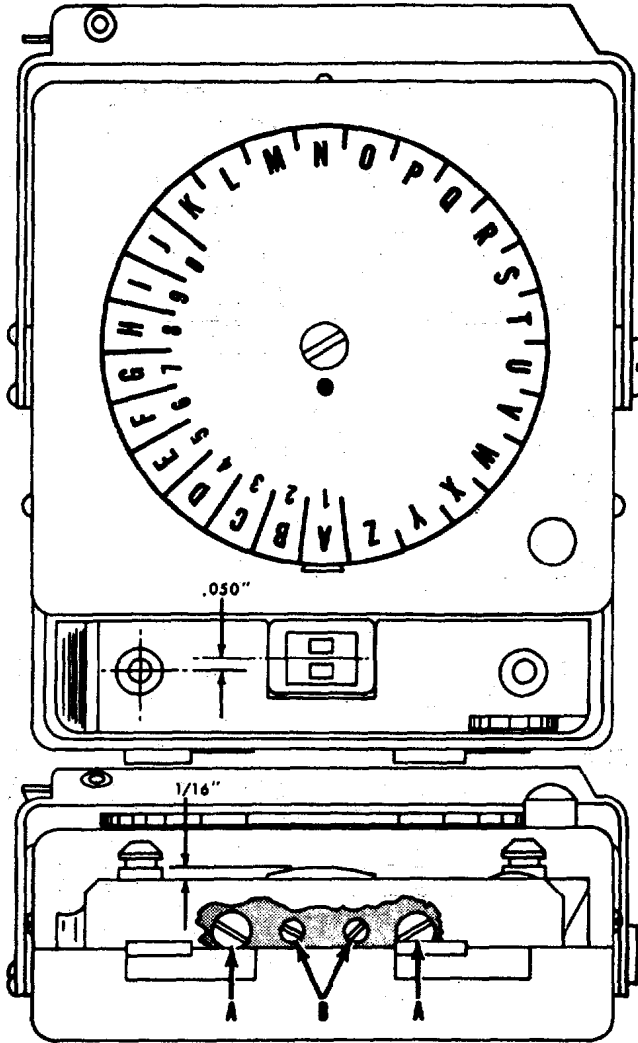

Figure 4-4. CO/B-8 Coder recording head alignment.

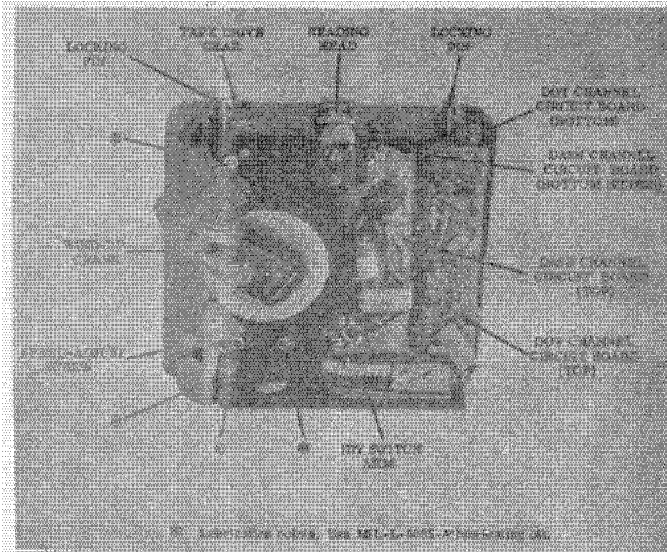

Figure 4-5. KE-8B Keyer internal mechanism.

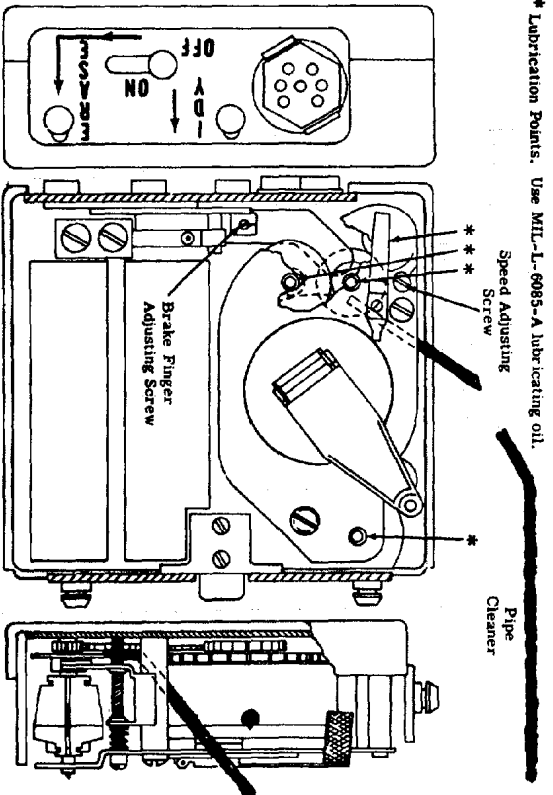

Figure 4-6. KE-8B Keyer brake disc cleaning and lubrication points.

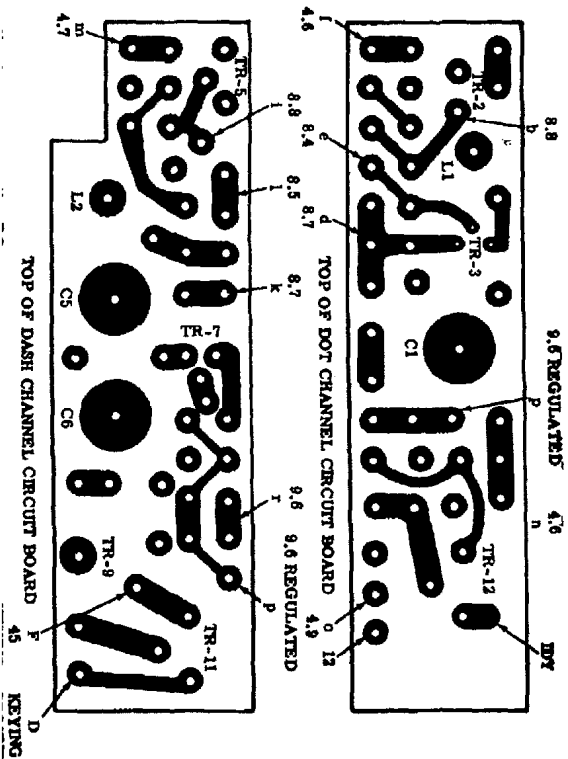

Figure 4-7. KE-3B Keyer circuit board test point diagram.

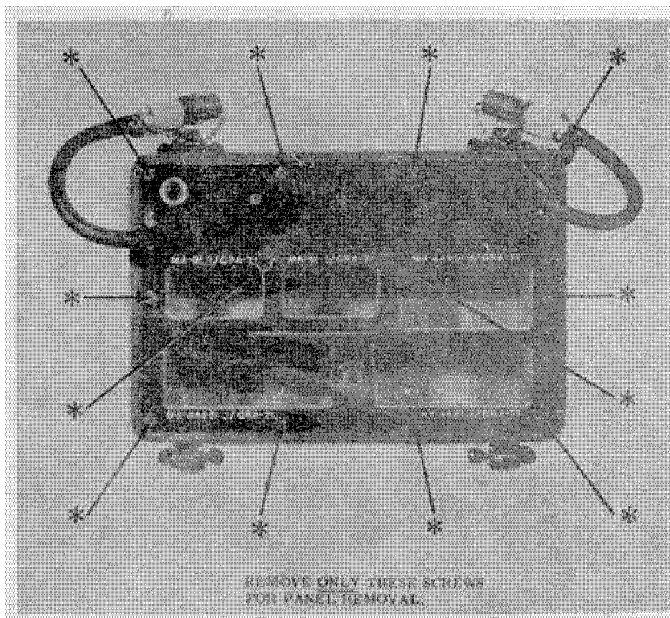

Figure 4-8. KA-3 Keyer Adapter panel removal.

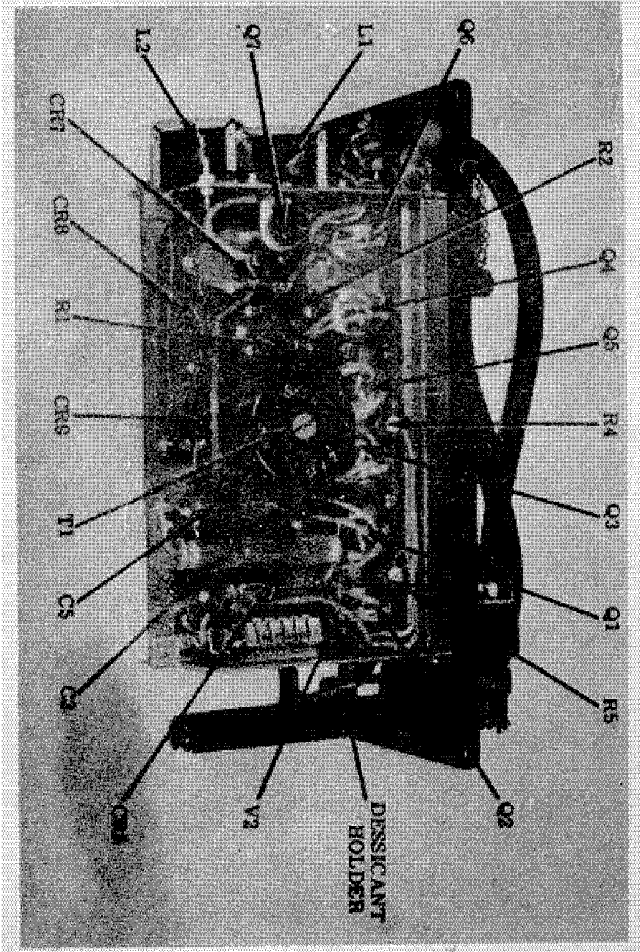

Figure 4-9. KA-3 Keyer Adapter electronics chassis, top view.

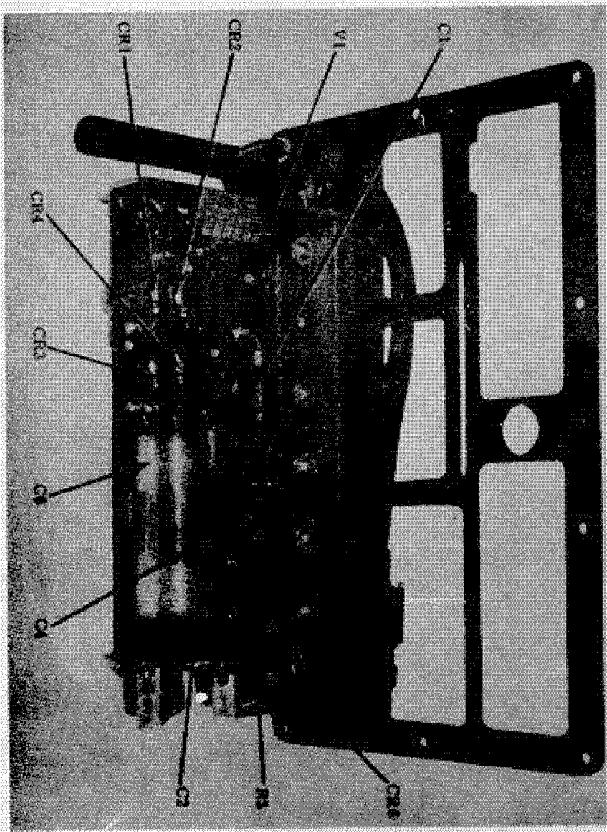

Figure 4-10. KA-3 Keyer Adapter electronics chassis, bottom view.

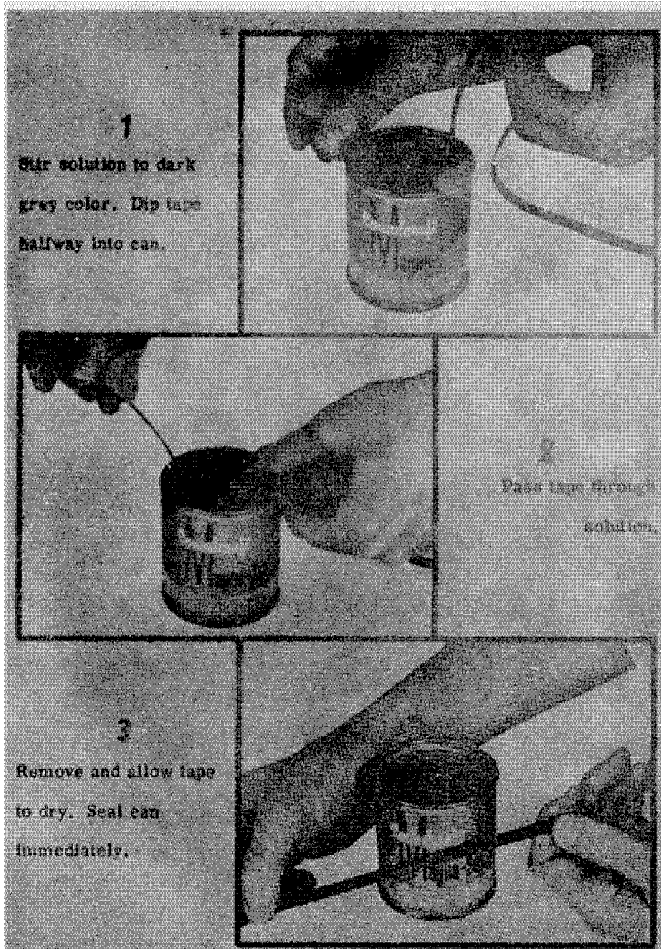

Figure 4-11. Magna-See tape developing procedure.

APPENDIX REFERENCES

Following is a list of references applicable and available to the operator and organizational repairman of the AN/GRA-71.

AR 70058	Report of Damaged or Improper Shipment.
DA Pam 3104	Index of Technical Manuals, Technical Bulletins, Supply Manuals (Types 4, 6, 7, 8, and 9), Supply Bulletins, Lubrication Orders, and Modification Work Orders.
MWO 11-5820474-35/1	Modification of Radio Set AN/GRC-109 to make it Compatible with Coder Burst Transmission Group AN/GRA-71.
TM 9-213	Painting Instructions for Field Use.
TM 115820-474-14	Operator Organizational, and Field Maintenance Manual: Radio Set AN/ GRC-109.
TM 38-750	The Army Equipment Record System and Procedures.

By Order of the Secretary of the Army:

EARLE G. WHEELER,
General, United States Army,
Chief of Staff.

Official:

J. C. LAMBERT,
Major General, United States Army,
The Adjutant General.

Distribution:

Active Army:
CNGB (1)
USASA (2)
C/COMMEL (7)
CofEngre (1)
TSG (1)
CofSptS (1)
USCONARC (5)
USAMC (5)
ARADCOM (2)
ARADCOM Rgn (2)
OS Maj Comd (3)
OS Base Comd (2)
LOGCOMD (2)
Armies (2)
Corps (2)
USA Corps (3)
MDW (1)
USAMICOM (4)
USAECOM (7)
USAMCOM (2)
USASCC (4)
USAREUR Spt Comd (5)
GENDEP (08) (2)
Army Dep (2) except
Lexington, Tobyhanna (12)
Sacramento (28) Ft Worth (8)

Letterkenny, Navajo, Savanna (5)
Sharpe, Charleston (3)
Sig Dep (OS) (12)
Sig Sec, GENDEP (OS) (5)
USAARMBD (2)
USAARTYBD (2)
USA Trans Bd (2)
USA Elct Mat Spt Agcy (9)
USA CD Agcy (1)
USARSOUTHCOM Sig Agcy (1)
Chicago Proc Dist (1)
1st Fld Sta, USASA (5)
Instl (2) except Ft Monmouth (63)
 Ft Gordon (5) Ft Huachuca (10)
 WSMR (5)
USA Elct R&D Activity, WSMR (13)
USATC AD (2)
USATC Armor (2)
USATC Engr (2)
USATC Inf (2)
USASTC (3)
USA Mbl Equip Cen (1)
USA Pictorial Cen (2)
WRAMC (1)
AMS (1)
USA Tml (1) except Oakland (5)
POE (1)
Sig Fld Maint Shops (3)
USAERDL (2)
CREEL (2)
Svc Colleges (2)
Br Svc Sch (2)
AFIP (1)
Army Library, TAGO (2)
11th Air Assault Div (3)
USATTCARC (1)
USATTCA (1)

USATTCG (1)
USATTCP (1)
Units org under fol TOE:
(2 each UNOINDC)
7,
11-16
11-57
11-98
11-117
11-155
11-157
11-500 AA-AE (4)
11-557
11-587
11-91
11-597
17
17-51
29-56
31-105
37
57

NG: None.

USAR: None.

For explanation of abbreviations used, see AR 320-50.

*U.S. GOVERNMENT PRINTING OFFICE : 1991 0 - 281-486 (42705)

*U.S. GOVERNMENT PRINTING OFFICE : 1988 0 - 208-251

RECOMMENDED CHANGES TO EQUIPMENT TECHNICAL PUBLICATIONS

		SOMETHING WRONG WITH PUBLICATION	
THEN... JOT DOWN THE DOPE ABOUT IT ON THIS FORM. CAREFULLY TEAR IT OUT, FOLD IT AND DROP IT IN THE MAIL.		FROM: (PRINT YOUR UNIT'S COMPLETE ADDRESS)	
PUBLICATION NUMBER		PUBLICATION DATE	DATE SENT
PUBLICATION TITLE		PUBLICATION TITLE	
IN THIS SPACE, TELL WHAT IS WRONG AND WHAT SHOULD BE DONE ABOUT IT.			
BE EXACT PIN-POINT WHERE IT IS			
PAGE NO.	PARA-GRAPH	FIGURE NO.	TABLE NO.
PRINTED NAME, GRADE OR TITLE AND TELEPHONE NUMBER		SIGN HERE	

FORM DA 2028-2 (1 JUL 79)

DA FORM 1 JUL 79 **2028-2**

PREVIOUS EDITIONS ARE OBSOLETE.

P.S.--IF YOUR OUTFIT WANTS TO KNOW ABOUT YOUR RECOMMENDATION MAKE A CARBON COPY OF THIS AND GIVE IT TO YOUR HEADQUARTERS.

PIN: 019010-000